

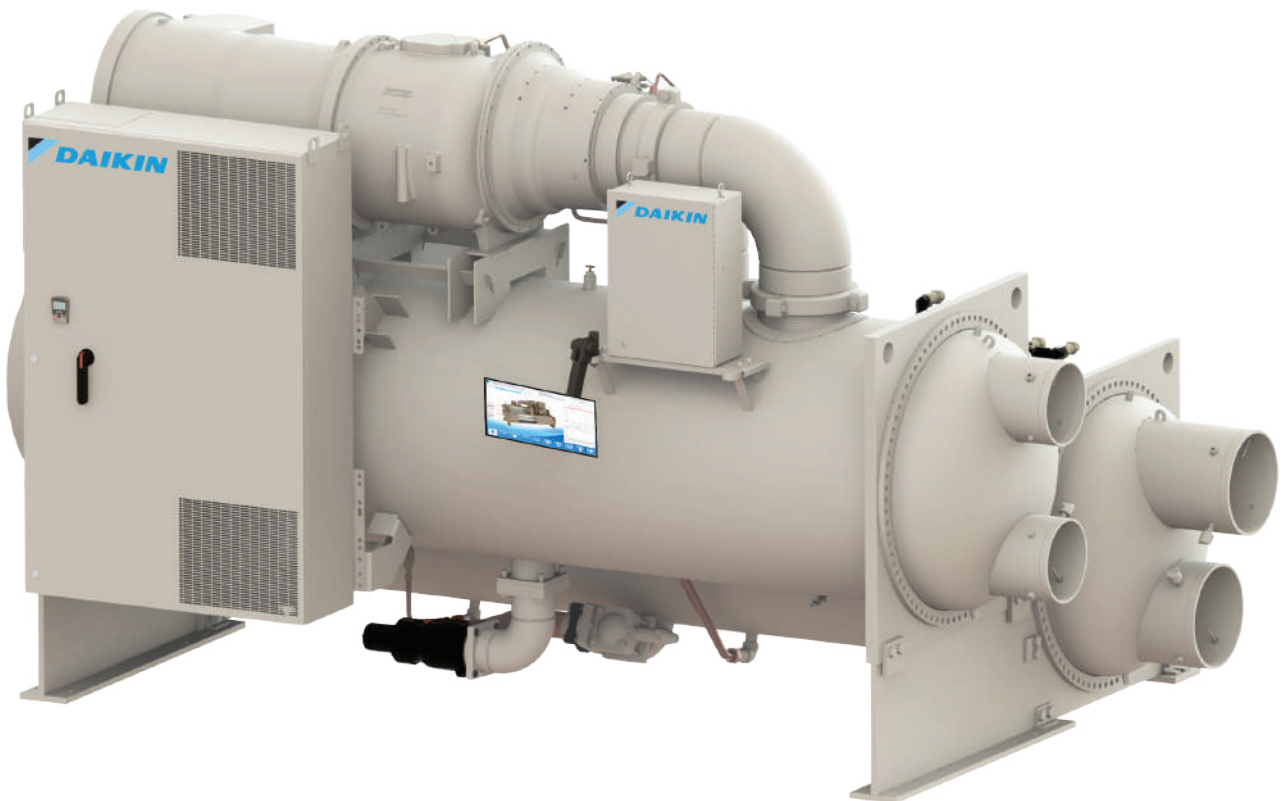

**Catalog 633-1**

## **Centrifugal Compressor Water-Cooled Chillers**

**Model WSC, B-vintage  
300 to 1800 Tons (700 to 6330 kW)  
R-134a Refrigerant  
60/50 Hz**



<b>Introduction</b> .....	<b>3</b>
<b>Features and Benefits</b> .....	<b>4</b>
<b>Unit Layouts</b> .....	<b>7</b>
<b>Options and Accessories</b> .....	<b>8</b>
<b>Retrofit Disassembly (Knockdown Options)</b> .....	<b>10</b>
<b>Electrical Data</b> .....	<b>11</b>
<b>Application Considerations</b> .....	<b>15</b>
<b>Engineering Guide Specifications</b> .....	<b>22</b>

**Manufactured in an ISO 9001 & ISO 14001 certified facility**



\* TSC and HSC models are outside the scope of AHRI certification program.

©2022 Daikin Applied. Illustrations and data cover the Daikin Applied product at the time of publication and we reserve the right to make changes in design and construction at any time without notice.

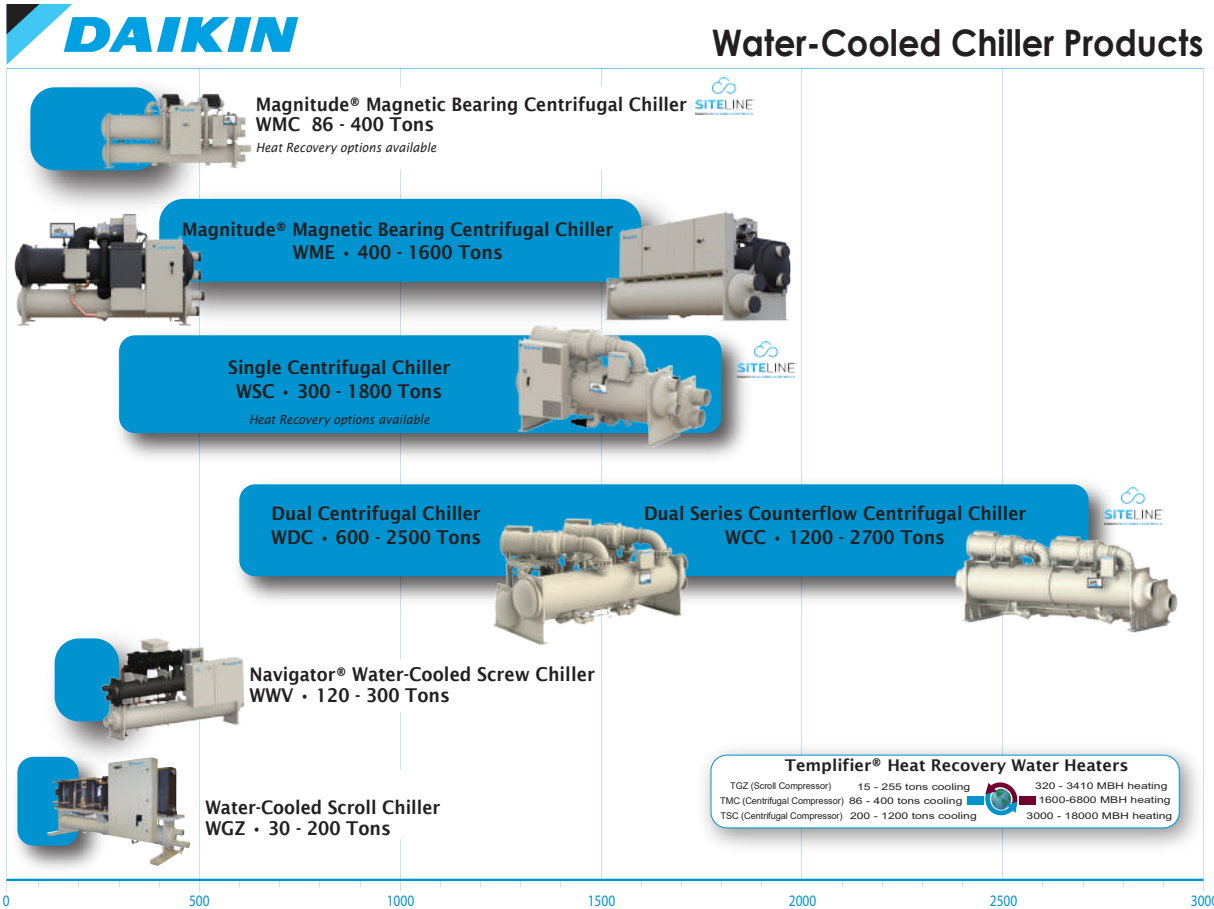

**Model WSC**

- Capacity: 300-1800 tons (AHRI conditions)
- Excellent part load efficiency with optional unit mounted VFD's
- Excellent full load performance
- Semi-hermetic gear-driven design
- Moveable discharge

Centrifugal Products included in separate manuals:

**Magnitude® Magnetic Bearing Compressor Chillers**

**Magnitude® Model WME**

- Capacity: 400-1600 tons
- Oil-free, frictionless compressor
- Outstanding efficiency

**Magnitude® Model WMC**

- Capacity: 86-400 tons
- Oil-free, frictionless compressor
- Excellent part-load performance
- See CAT 628 for more information

Centrifugal Products included in separate manuals:

**Centrifugal Dual Compressor Model WDC**

- Capacity: 600-2500 tons (AHRI conditions)
- Outstanding part load performance
- Redundancy for increased reliability
- Some sizes available with 10/11kV50Hz power option
- See CAT 605 for more information

**Centrifugal Dual Compressor Model WCC**

- Capacity: 1200-2700 tons (AHRI conditions)
- Two refrigerant circuits for true counterflow. Built-in redundancy with dual compressors and dual circuits
- Outstanding full load performance
- Some sizes available with 10/11kV50Hz power option
- Available single water pass arrangement to reduce pump energy costs
- See CAT 605 for more information

**Templifier® Model TSC Water Heater**

- Recovers waste heat from process applications
- 3,000 - 18,000 MBH
- Hot water - 137°F; COP as high as 7

## World-Class Design Leader

As part of Daikin Industries, a Fortune Global 500 company, Daikin is the world's largest air conditioning, heating, ventilating and refrigeration company. We have earned a worldwide reputation for providing a full line of quality products and expertise to meet the demands of our customers. The engineered flexibility of our products allows you to fine tune your HVAC system to meet the specific requirements of your application. You benefit from lower installed and operating costs, high energy efficiency, quiet operation, superior indoor air quality (IAQ) and low cost maintenance and service.

## Design Features

### Excellent Performance

Daikin offers a wide range of centrifugal vessel and component combinations to provide the right solution for your specific application. The single compressor WSC offers excellent full load performance. Our dual compressor WDC chillers offer many benefits, including outstanding part-load efficiency, and system redundancy similar to two separate chillers, with a lower total installed cost. WCC models also offer the dual compressor advantage, but with counterflow vessels and a separate refrigerant circuit for each compressor. In addition, the WCC excels in full load efficiency. Contact your Daikin representative for detailed information to decide which model is right for your job requirements.

**Figure 1: Centrifugal Models & Recommended Applications**

Application	Daikin Model
Cooling <1800 tons, most hours at full load	WSC
Cooling >1250 tons, most hours at full load	WCC
Cooling, most hours at part load	WDC
Heating Application	TSC
Simultaneous Cooling and Heating	HSC
Optimized Part Load Performance	Optional VFD

### Gear Driven Advantage

Daikin's precision-engineered gear driven design allows for lighter components, less vibration, and ability to select gear ratios that will provide the optimum impeller speed for your application. Older direct-drive designs must use large, heavy impellers to reach similar tip speeds, which cause more vibration and greater stress on shaft and motor during unexpected electrical interruptions.

The compact design and lighter weight components allow for efficient hydrodynamic bearings to be used (079-126 compressor models). This means that during operation, the shaft is supported on a film of lubricant, with no shaft-to-bearing contact, providing theoretical infinite life bearings under normal circumstances. The design simplicity of the Daikin

centrifugal compressors provides increased durability and reliable performance. For the 160 compressor, an anti-friction bearing is used due to the increased weight of stator motor.

### Smart Refrigerant

HFC-134a refrigerant contains no chlorine and has zero Ozone Depletion Potential (ODP), making it an environmentally superior alternative to other refrigerants such as HCFC-123. It also has an A1 ASHRAE Safety Classification - the lowest toxicity and flammability rating. R-134a provides the assurance of a safe, smart, and sustainable solution, with the additional peace of mind of no phase-out date.

R-123 requires about six times the gas flow rate (cfm/ton) of R-134a, which means that the suction and discharge piping must also be six times larger. Using R-134a allows Daikin to provide you with a smaller footprint chiller.

**Table 1: Refrigerant Comparison**

	HFC-134a	HCFC-R-123 / R-514A
ENVIRONMENTAL	No Ozone Depletion Potential	Ozone-depleting substance (R-123 only)
	No Refrigerant Phase Out Date	Montreal Protocol requires phase out in new equipment by the end of 2019; production cease by 2030 (R-123 only)
INSTALLATION AND MAINTENANCE	Physically smaller, requiring less mechanical room space.	Requires larger refrigerant flow rate, with subsequent increase in compressor and chiller size.
	No oil change is required	Annual oil change is recommended
SAFETY	A1 ASHRAE Safety Classification -lowest toxicity/flammability rating	B1 ASHRAE Safety Classification- higher toxicity level

See [www.DaikinApplied.com /Daikin/DesignSolutions/RefrigerantResourceCenter](http://www.DaikinApplied.com/Daikin/DesignSolutions/RefrigerantResourceCenter) for references and more information

### Exceptional Unloading

Daikin pioneered the use of moveable discharge geometry to lower the surge point of centrifugal compressors. The point at which the compressor enters a stall or surge condition generally limits compressor unloading. Chillers with a fixed discharge will experience stall or surge at low loads due to refrigerant re-entering the impeller. When in a stall condition, the refrigerant gas is unable to enter the volute due to its low velocity and remains stalled in the impeller. In a surge condition the gas rapidly reverses direction in the impeller causing excessive vibration and heat. Daikin compressors reduce the discharge area as load decreases to maintain gas velocity and greatly reduce the tendency to stall or surge.

**Figure 2: Fixed vs. Moveable Discharge Geometry**

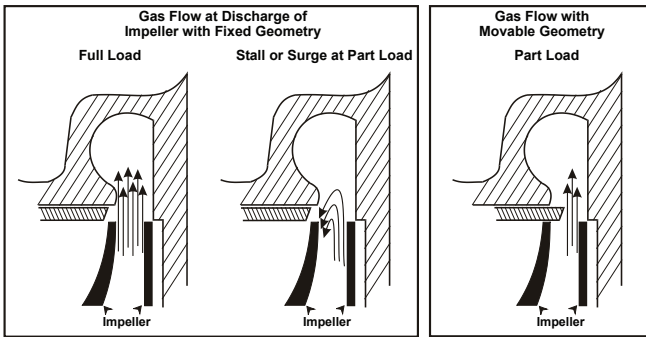

In **Figure 2**, the drawing on the left shows a cross-section view of the operation at full load of a unit with a fixed compressor discharge. At full load, a large quantity of gas is discharged with a fairly uniform discharge velocity as indicated by the arrows.

The center drawing shows a fixed compressor discharge at reduced capacity. Note that the velocity is not uniform and the refrigerant tends to reenter the impeller. This is caused by low velocity in the discharge area and the high pressure in the condenser, resulting in unstable surge operation and with noise and vibration generated.

**Figure 3** shows the unique Daikin movable discharge geometry. As the capacity reduces, the movable unloader piston travels inward, reducing the discharge cross section area and maintaining the refrigerant velocity. This mechanism allows our excellent unloading capacity reduction.

**Figure 3: Moveable diffuser closes impeller discharge area as load decreases**

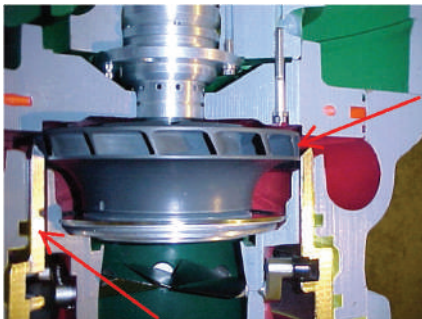

**Trouble-Free Startup**

All Daikin chillers are factory tested on AHRI qualified computer-controlled test stands. Operating controls are checked and adjusted, and the refrigerant charge is adjusted for optimum operation and recorded on the unit nameplate. The testing helps ensure correct operation prior to shipment, and allows factory calibration of chiller operating controls.

All domestic Daikin centrifugal chillers are commissioned by your service representative for Daikin Applied, or by authorized and experienced Daikin Applied startup technicians. This procedure helps ensure that proper starting and

checkout procedures are employed and helps in a speedy commissioning process, giving you confidence that your chiller is operating as expected.

**Lubrication System**

A separately driven electric oil pump assembly supplies lubrication at controlled temperature and pressure to all bearing surfaces and is the source of hydraulic pressure for the capacity control system.

The control system will not allow the compressor to start until oil pressure, at the proper temperature, is established. It also allows the oil pump to operate after compressor shutdown to provide lubrication during coast-down. Lubricant from the pump is supplied to the compressor through a water-cooled, brazed-plate heat exchanger and single or dual five-micron oil filters internal to the compressor. All bearing surfaces are pressure lubricated. Drive gears operate in a controlled lubricant mist atmosphere that efficiently cools and lubricates them.

Lubricant is made available under pressure from the compressor oil filter to the unit capacity control system and is used to position the inlet guide vanes in response to changes in leaving chiller water temperature.

If a power failure occurs, an emergency oil reservoir provides adequate lubrication flow under pressure, and prevents damage that could occur during the coast-down period with the oil pump stopped.

Since Daikin chillers are positive pressure, there is no need to change the lubricant or filter on a regular basis. As with any equipment of this type, an annual oil check is recommended to evaluate the lubricant condition.

**Figure 4: Lubrication System Schematic**

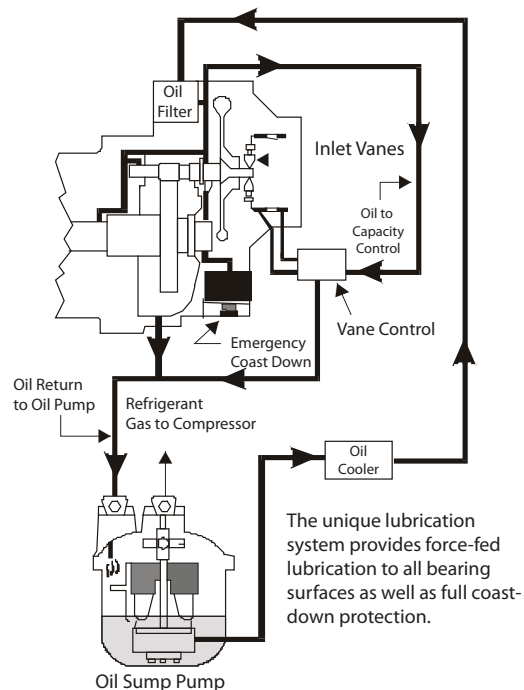

The unique lubrication system provides force-fed lubrication to all bearing surfaces as well as full coast-down protection.

## Enhanced Surge Protection

When centrifugal compressors operate at part load, the volume of refrigerant gas entering the impeller is reduced. At the reduced flow, the impeller's capacity to develop the peak load head is also reduced. At conditions of low refrigerant flow and high compressor head (pressure difference), stall and/or surge can occur (a stall is gas static in the impeller, a surge condition is gas rapidly reversing direction through the impeller). A number of things can contribute to this condition including inadequate maintenance of condenser tube cleanliness, a cooling tower or control malfunction, or unusual ambient temperatures among others.

For these abnormal conditions, Daikin compressor designers have developed a protective control system that senses the potential for a surge, looks at the entire chiller system operation and takes corrective action if possible; or stops the compressor, to help prevent any damage from occurring. This protection is provided as standard on all Daikin centrifugal compressors.

## The Replacement Market Advantage

- Retrofit flexibility allows an easy retrofit with flexible knock-down options. See [page 10](#) for details.
- Bolt-together construction on single and dual compressor chillers along with factory disassembly available as an option simplify tough entrance situations.
- Opens many options for multiple chiller plants using WDC and WCC combinations.

## Heat Recovery Models

For decades, Daikin has pioneered the use of heat recovery chillers and the unique Daikin Templifier® Heat Pump Water Heater to reduce energy costs. These products have become more important than ever with the current emphasis on total building efficiency. ASHRAE Efficiency Standard 90.1 mandates the use of heat recovery equipment of this type in a wide range of buildings.

### *Heat Recovery Chillers*

Model HSC heat recovery chillers, with a single compressor, have a single condenser with split bundles, i.e., two separate water passages divided by separate water heads. The inboard water connections are connected to the cooling tower, the other water side is connected to the heating system. The economic feasibility of hot water generated with these units depends on heating and cooling load profiles and on the relative cost of the available energy sources. A compressor's kW per ton is heavily influenced by the pressure head it is pumping against. During heat recovery operation, the entire cooling load is operating against the high head required by the hot water temperature. For this reason, it is desirable to maximize the percentage of the total rejected heat used for the heating load. Daikin's economic evaluation program, Energy Analyzer® 3, available from your local Daikin sales office, is the perfect tool to determine the economic feasibility of using this proven technology.

Figure 5: WSC Layout

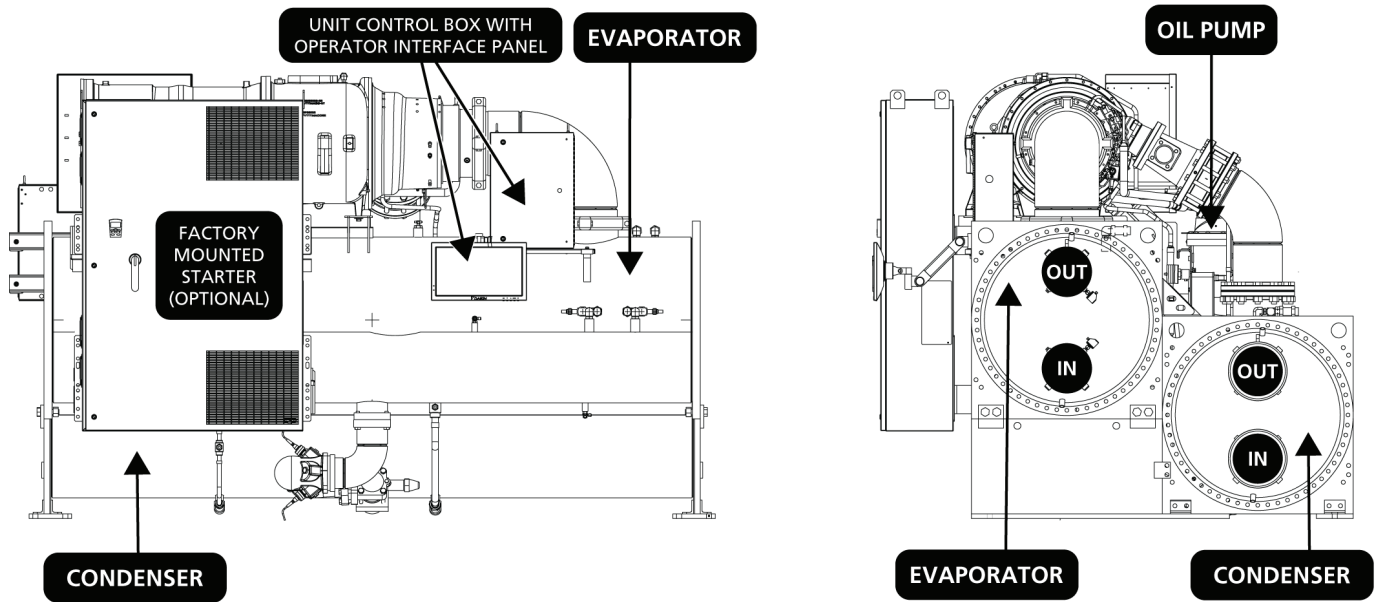

**NOTE:** Contact the Daikin Applied sales office for full dimensional information

## Vessels

### **Marine water boxes**

Provides tube access for inspection, cleaning, and removal without dismantling water piping.

### **Flanges**

ANSI raised face flanges on either the evaporator or condenser. Mating flanges are by others. Grooved connections are standard.

### **0.028 or 0.035 in. tube wall thickness**

For applications with aggressive water conditions requiring thicker tube walls. The standard tube wall thickness is 0.025 in.

### **Cupro-nickel or titanium tube material**

For use with corrosive water conditions, includes clad tube sheets and coated water heads. The standard tube material is copper.

### **Water-side vessel construction of 300 psi (150 psi is standard)**

For high-pressure water systems, typically high-rise building construction.

### **Water differential pressure switches**

This option provides evaporator and condenser water thermal dispersion flow sensors as a factory mounted and wired option. A proof-of-flow device is mandatory in both the chilled water and condenser water systems.

### **Single insulation**

¾-inch on evaporator, suction piping, and motor barrel; for normal machine room applications.

### **Double insulation**

1-½ inch on evaporator, suction piping, and motor barrel; for high humidity locations and ice making applications.

## Electrical

### **Variable Frequency Drives (VFD)**

The Variable Frequency Drive option is a technology that is used to control motor speed on a wide variety of motor-drive applications. When applied to centrifugal compressor motors, significant gains in compressor part load performance can be realized. The improvement in efficiency and reduction of annual energy cost is maximized when there are long periods of part load operation, combined with low compressor lift (lower condenser water temperatures). When atmospheric conditions permit, Daikin chillers equipped with VFDs can operate with entering condenser as low as 55°F (13°C), which results in extremely low kW/ton values.

Starting Inrush: The use of a VFD on centrifugal chillers also

provides an excellent method of reducing motor starting inrush, which is even better than solid-state starters. Starting current can be closely controlled since both the frequency and voltage are regulated. This can be an important benefit to a building's electrical distribution system.

### **Optional starters for factory or field mounting**

See details in "Starter Types and Descriptions" on page 11.

### **NEMA 4 watertight enclosure**

For use where there is a possibility of water intrusion into the control panel.

### **NEMA 12 Dust tight enclosure**

For use in dusty areas.

## Controls

### **English or Metric Display**

Either English or metric units for operator ease of use.

### **BAS Interface Module**

Factory-installed on the unit controller (can also be retrofitted for integration to BAS using LonTalk®, BACnet® or Modbus® protocol)

## Unit

### **Export packaging**

Can be either slat or full crate for additional protection during shipment. Units normally shipped in containers.

### **Pumpout Unit, Model RRU with or without storage vessel**

Available in a variety of sizes.

### **Hot gas bypass**

Reduces compressor cycling and its attendant chilled water temperature swings at very low loads.

### **Sound attenuation package**

For extremely sensitive projects, an optional discharge line sound package is offered consisting of sound insulation installed on the unit's discharge line. An additional 2 to 4 dbA reduction normally occurs.

### **Extended warranties**

Extended 1, 2, 3, or 4-year warranties for parts only or for parts and labor are available for the entire unit, refrigerant, or compressor/motor only.

### **Optional Certified Test**



A Daikin engineer oversees the testing, certifies the accuracy of the computerized results, and then translates the test data onto an easy-to-read spreadsheet. The tests can be run at AHRI load points and are run to AHRI tolerance of capacity and power. A test result booklet will be provided.

### ***Optional Witness Test***

A Daikin engineer oversees the testing in the presence of the customer or their designate and translates the test data onto an easy-to-read spreadsheet. The tests can be run at AHRI load points and are run to AHRI tolerance of capacity and power. Allow two to three hours of test time per load point specified. A test result booklet will be provided.

### ***Special Order Options***

The following special order options are available below. They may require factory pricing, additional engineering, possible dimensional changes, or extended delivery times:

- Non-standard location of nozzle connections on heads (compact water boxes) or marine water boxes
- Special corrosion inhibiting coatings on any “wetted surface” including tubesheets, heads (compact water boxes), marine water boxes, or nozzles
- Clad tube sheets
- Sacrificial anodes in heads (compact water boxes) or marine water boxes
- Eddy current testing and report used to verify baseline tube condition
- Special NEMA enclosures
- Hinges for marine water box covers or heads (compact water boxes)
- Spacer rings on heads to accommodate automatic tube brush cleaning systems (installed by others)

Consult the Daikin sales office for other possible specials.

## On-site Disassembly

The major components (evaporator, condenser, and compressor) are shipped fully assembled and charged and can be taken apart at the site to facilitate difficult rigging work. The chillers are shipped assembled from the factory after testing, and then disassembled and reassembled on site under supervision of authorized Daikin service personnel. Contact local Daikin Factory Service for price quotation and scheduling.

## Shipped Disassembled

Chillers can be shipped knocked down from the factory. The evaporator, condenser and oil pump are shipped bolted together and easily unbolted at the job site into the pieces shown on the following page. Other options, such as shipping less compressor or less compressor and control panel are also available. Site reassembly must be supervised by Daikin startup personnel. Contact local Daikin Factory Service for price quotation and scheduling.

## Type A Knockdown

The units are shipped fully assembled, factory charged, run-tested, insulated and painted. Included are the vessel bolt-on connection brackets, discharge line bolt-on flanges at the condenser and bolt-on oil pump assembly. Site disassembly and reassembly must be supervised by Daikin startup personnel. Contact local Daikin Factory Service for price quotation and scheduling.

## Type B Knockdown

Daikin provides ease of installation without requiring construction alterations of entryways to your building. The compressor and compressor control box are removed and put on a skid. All associated wiring and piping will remain attached if possible. The remaining loose parts will be packaged in a separate crate.

1. Blockoffs will cover all openings on the compressor and vessels.
2. The compressor and vessels will receive a helium holding charge.
3. The compressor will not be insulated at the factory. An insulation kit will be shipped with the unit.
4. The starter will ship loose. Bracket and cable kit to be included for unit-mounted starters and/or cableway for mini-cabinet.
5. The evaporator will be insulated at the factory.
6. Refrigerant will not be shipped with the unit and must be secured locally and furnished and installed by the installer.
7. Oil will be shipped in containers from the factory for field installation.
8. All field-piping connections will be victaulic, o-ring face seal or copper brazing.

9. All free piping ends will be capped.
10. Touch-up paint will be included.
11. The unit will undergo the standard, rigorous, full factory test program.

Contact local Daikin Factory Service for price quotation and scheduling.

## Wiring and Conduit

Wire sizes must comply with local and state electrical codes. Where total amperes require larger conductors than a single conduit would permit, limited by dimensions of motor terminal box, two or more conduits can be used. Where multiple conduits are used, all three phases must be balanced in each conduit. Failure to balance each conduit will result in excessive heating of the conductors and unbalanced voltage.

An interposing relay can be required on remote mounted starter applications when the length of the conductors run between the chiller and starter is excessive.

Use only copper supply wires with ampacity based on 75°C conductor rating. (Exception: for equipment rated over 2000 volts, 90°C or 105°C rated conductors shall be used).

## Power Factor Correction Capacitors

Do not use power factor correction capacitors with centrifugal chillers with a compressor VFD. Doing so can cause harmful electrical resonance in the system. Correction capacitors are not necessary since VFDs inherently maintain high power factors.

## Control Power

The 115-volt control power can be supplied from the starter or a transformer (meeting the requirements of Daikin Starter Specification 359999 Rev 29) separate from the starter. Either source must be properly fused with 25-amp dual element fuses or with a circuit breaker selected for motor duty. If the control transformer or other power source for the control panel is remote from the unit, conductors must be sized for a maximum voltage drop of 3%. Required circuit ampacity is 25 amps at 115 volts. Conductor size for long runs between the control panel and power source, based upon National Electrical Code limitations for 3% voltage drop, can be determined from the table below.

**Table 2: Control Power Line Sizing**

Maximum Length, ft (m)	Wire Size (AWG)	Maximum Length, ft (m)	Wire Size (AWG)
0 (0) to 50 (15.2)	12	120 (36.6) to 200 (61.0)	6
50 (15.2) to 75 (22.9)	10	200 (61.0) to 275 (83.8)	4
75 (22.9) to 120 (36.6)	8	275 (83.8) to 350 (106.7)	3

Notes:

1. Maximum length is the distance a conductor will traverse between the control power source and the unit control panel.
2. Panel terminal connectors will accommodate up to number 10 AWG wire. Larger conductors will require an intermediate junction box.

## Starter Types and Descriptions

Daikin offers a variety of motor and starter types to fit a wide array of applications. Solid State, Across-The-Line, and Fixed Speed by Others starter types are available for fixed speed options, while Variable Frequency Drives (VFDs) are offered for variable speed operation. For additional information on starters and VFDs, consult your local Daikin sales office.

Some voltage and starter type configurations can be unit mounted and wired at the factory, but when the unit mounted starters are too large to ship on the unit, they are shipped loose with cable kits and mounting brackets for field installation on the unit by others. Additionally, freestanding starters are furnished by Daikin and shipped to the job site for setting and wiring by others. Fixed Speed by Others starters are furnished and installed by others, but must meet Daikin Specification 359999 Rev 29, available at your local Daikin sales office.

**Table 3: Starter Mounting Options by Voltage**

Product Line	Starter Type	Mounting Location	Low Voltage (200-575V) Medium Voltage (2400-6600V) High Voltage (10000-13800V)
WSC	VFD	Unit Mounted	Low Voltage Only
		Free Standing	Low Voltage Only
	SSS	Unit Mounted	Low Voltage Only
		Free Standing	Low & Medium Voltage
	ATL	Unit Mounted	N/A
		Free Standing	Medium Voltage Only
Fixed Speed by Others		Low, Medium, & High Voltage	

## Variable Frequency Drives (VFD)

A VFD modulates the compressor speed in response to load and vessel pressures, resulting in excellent part load performance. VFDs are most beneficial when there is reduced load and low compressor lift (condenser water temperatures) dominating the operating hours.

The traditional method of controlling centrifugal compressor capacity is with inlet guide vanes (IGVs). However, capacity is most optimally reduced by using both a VFD and IGVs. The VFD slows the compressor (impeller tip) speed as much as possible to make the required compressor lift, while IGVs take over to make up the difference in required capacity reduction

The chart below illustrates the relative IPLV efficiencies of Daikin models for a typical 1,200 Ton selection at AHRI conditions. VFD's offer a significant improvement in part load performance compared to their fixed speed counterparts.

**Figure 6: IPLV Comparison by Model**

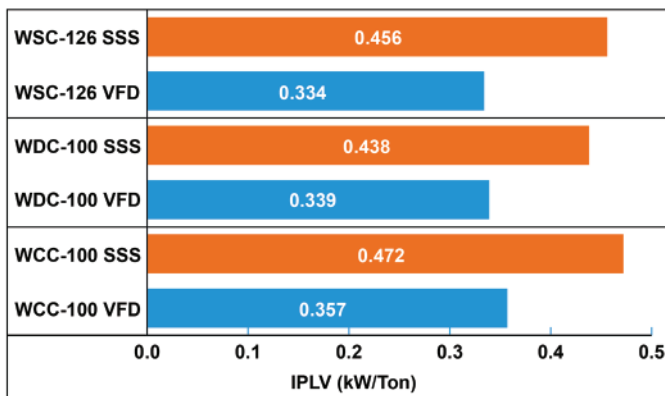

The IPLV values (defined on page 29) are AHRI Certified Ratings based on AHRI Standard 550/590, Standard for Water Chilling Packages Using the Vapor Compression Cycle. Full load is at 44 F chilled water temperature with 2.4 gpm/ton, 85 F entering condenser water temperatures with 3 gpm/ton. Part load points of 75%, 50%, and 25% employ condenser water temperature relief (reduction) per the standard.

## VFDs and Distortion

Despite the many benefits, care must be taken when applying VFDs due to the impact that they may have on the building's electrical system. VFDs can cause distortion of the AC line because they are nonlinear loads; that is, they don't draw sinusoidal current from the line. They instead only draw current during the peaks of the AC line. This flattens the top of the voltage waveform. Most other modern electronic equipment is also a nonlinear load, but VFDs tend to have a greater impact because of their large power demand. Although harmonics are associated with non-linear loads, it is extremely rare that VFD generated harmonics are an issue in systems with a minimum of 5% internal impedance.

Power line harmonic distortion can be a concern for a number of reasons:

1. Current harmonics can cause additional heating of transformers, conductors, and switchgear. They can also cause nuisance tripping of circuit breakers and clearing of fuses.
2. Voltage harmonics may disrupt the operation of devices which require a smooth, sinusoidal voltage waveform.
3. High-frequency components of voltage distortion can interfere with signals which are transmitted on the AC power line.

The harmonics of concern are often the 5th, 7th, 11th, and 13th. Even harmonics, harmonics divisible by three, and harmonics above the 13th harmonic are usually not a problem for three-phase power systems.

The optional Daikin Drive Passive Filter Package provides a broader range of harmonic reduction performance than VFDs, which use active rectifiers. This is particularly true at reduced loads, where VFDs provide the greatest energy savings.

## Current Harmonics

An increase in reactive impedance in front of the VFD helps reduce the harmonic currents. Reactive impedance can be added in the following ways:

1. Mount the drive far from the source transformer.
2. Add line reactors.
3. Use an isolation transformer.

## Voltage Harmonics

Voltage distortion is caused by the flow of harmonic currents through a source impedance. A reduction in source impedance to the point of common coupling (PCC) will result in a reduction in voltage harmonics. This may be done in the following ways:

1. Keep the PCC as far from the drives (close to the power source) as possible.
2. Increase the size (decrease the impedance) of the source transformer.
3. Increase the capacity (decrease the impedance) of the busway or cables from the source to the PCC.
4. Make sure that added reactance is downstream (closer to the VFD than the source) from the PCC.

## The IEEE 519 Standard

The Institute of Electrical and Electronics Engineers (IEEE) has developed a standard that recommends distortion limits for both power utilities and their customers. The purpose of these limits is to ensure that the voltage distortion of the utility's public power grid is maintained at an acceptable level. To accomplish this, IEEE 519-2014 presents recommended harmonic current distortion limits for utility customers. These limits are based on the peak demand of the customer. This is called the Total Demand Distortion (TDD). This standard provides a sliding scale for the recommended TDD limit for each utility customer. The greater the demand that a customer places on the utility, the more stringent the recommended TDD limits.

IEEE 519-2014 clearly states that the TDD is to be measured at the point where a utility customer connects to the public utility. It does not apply to any points inside the customer's facility; it only applies to the point where another utility customer could connect to the public power grid. If the utility's customers comply with the TDD limits stated in IEEE 519-2014, it is then the utility's responsibility to provide voltage to its customers that meets the harmonic voltage recommendations of this standard.

Actual optimum unit selection will vary with building application and system design. Applications with minimal hours of operation cannot justify a very low kW per ton (COP) unit. Applications with high hours of operation will justify high part load as well as full load efficiency units. For optimum selection an energy analysis is available through your local Daikin Applied sales representative.

Notes for following Wiring Diagram:

1. Optional Open Choices BAS interfaces. The locations and interconnection requirements for the various standard protocols are found in their respective installation manuals, obtainable from the local Daikin sales office and also shipped with each unit: Modbus IM 743, LonWorks IM 735, and BACnet IM 736.
2. The "Full Metering" or "Amps Only Metering" option will require some field wiring when free-standing starters are used. Wiring will depend on chiller and starter type. Consult the local Daikin sales office for information on specific selections.

Figure 7: WSC Typical Field Connection Diagram

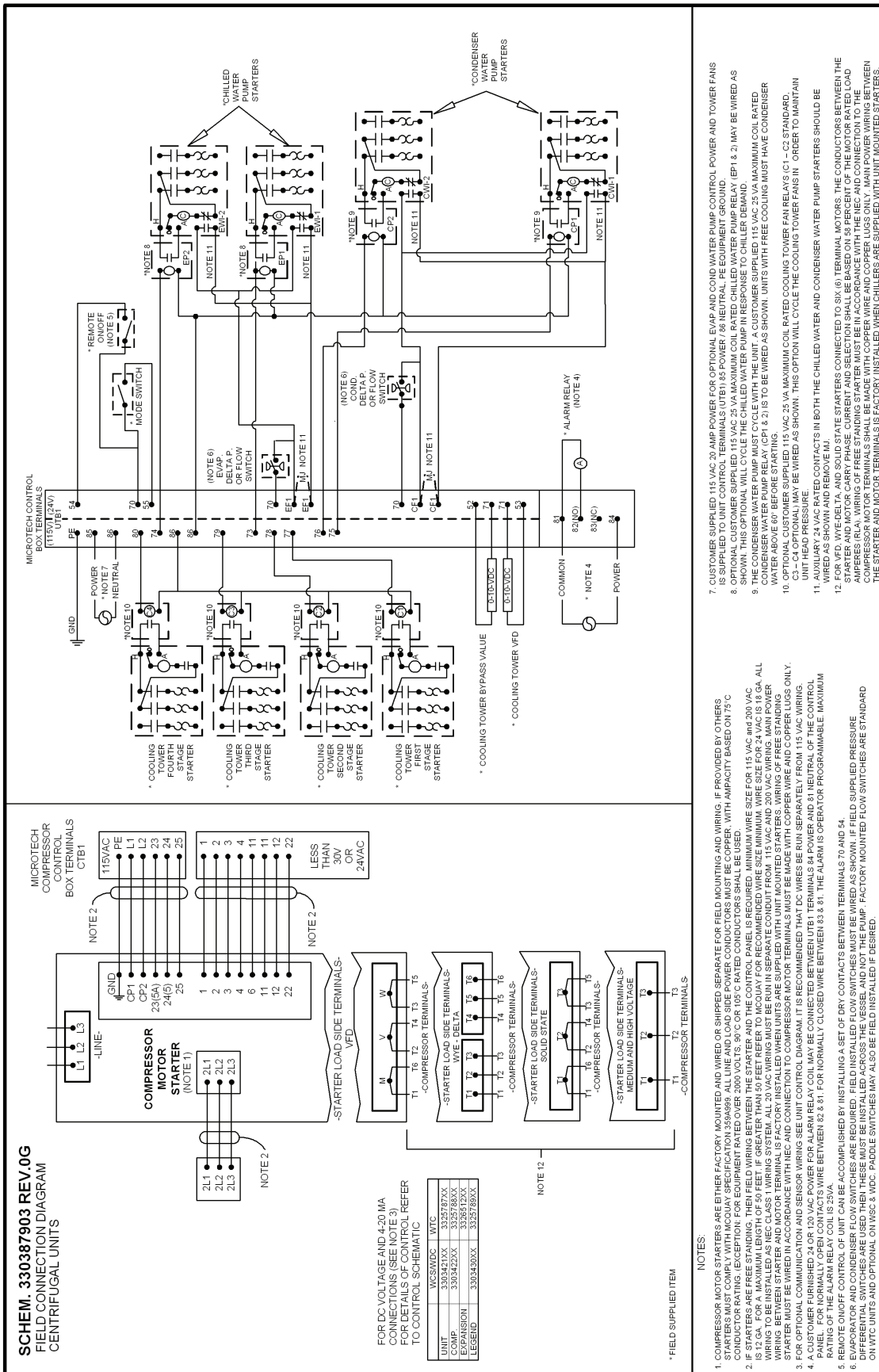

## Location

These chillers are intended only for installation in an indoor or weather protected area consistent with the NEMA 1 rating on the chiller, controls, and electrical panels. If indoor sub-freezing temperatures are possible, special precautions must be taken to avoid equipment damage.

 <b>CAUTION</b>
Daikin Centrifugal Chillers are intended only for installation in indoor areas protected from temperature extremes. Failure to comply may result in equipment damage and may void the manufacturer warranty.

## Operating/Standby Limits

**Table 4: Operating/Standby Limits**

Equipment room operating temperature:	40°-104°F (4.4°-40°C)
Equipment room temperature, standby, with water in vessels and oil cooler:	40°-104°F (4.4°-40°C)
Equipment room temperature, standby, without water in vessels and oil cooler:	0°F-122F (-18°C-50°C)
Maximum entering condenser water temperature, startup:	design + 5°F (2.7°C)
Maximum entering condenser water temperature, operating:	job-specific design temperature
Minimum entering condenser water temperature, operating:	see <a href="#">page 16</a> for more detail
Minimum leaving chilled water temperature:	38°F (3.3°C)
Minimum leaving chilled fluid temperature with correct anti-freeze fluid:	15°F (-9.4°C)
Maximum entering chilled water temperature, operating:	90°F (32.2°C)
Maximum oil cooler or VFD entering temperature:	80°F (26.7°C)
Minimum oil cooler/VFD entering temperature:	42°F (5.6°C)

## Water Piping

All evaporators and condensers have OGS-type grooved water connections (adhering to Standard AWWA C606) or optional flange connections. The installing contractor must provide matching mechanical connections. PVC piping should not be used. Be sure that water inlet and outlet connections match certified drawings and nozzle markings.

 <b>CAUTION</b>
If welding is to be performed on the mechanical or flange connections:
<ol style="list-style-type: none"> <li>1. Remove the solid-state temperature sensor, thermostat bulbs, and nozzle mounted flow switches from the wells to prevent damage to those components.</li> <li>2. Properly ground the unit or severe damage to the MicroTech® unit controller can occur.</li> </ol>
<b>NOTE:</b> ASME certification will be revoked if welding is performed on a vessel shell or tube sheet.

The water heads can be interchanged (end for end) so that the water connections can be made at either end of the unit. If this is done, use new head gaskets and relocate the control sensors.

Field installed water piping to the chiller must include:

- air vents at the high points.
- a cleanable water strainer upstream of the evaporator and condenser inlet connections.
- a flow proving device for both the evaporator and condenser to prevent freeze up. Flow switches, thermal dispersion switches, or Delta-P switches can be used. Note that flow switches are factory installed. Additional flow switches can be used only if they are connected in series with the ones already provided. Connect additional flow switches in series between original flow switch inputs.
- sufficient shutoff valves to allow vessel isolation. The chiller must be capable of draining the water from the evaporator or condenser without draining the complete system.

It is recommended that field installed water piping to the chiller include:

- thermometers at the inlet and outlet connections of both vessels.
- water pressure gauge connection taps and gauges at the inlet and outlet connections of both vessels for measuring water pressure drop.

The piping must be supported to eliminate weight and strain on the fittings and connections. Piping must also be adequately insulated. Sufficient shutoff valves must be installed to permit draining the water from the evaporator or condenser without draining the complete system.

### **Optimum Water Temperatures and Flow Rates**

A key to improving energy efficiency for any chiller is minimizing the compressor pressure lift. Reducing the lift reduces the compressor work and its energy consumption per unit of output.

The optimum plant design must take into account all of the interactions between chiller, pumps, and tower. The Daikin Energy Analyzer® 3 program is an excellent tool to investigate the entire system efficiency, quickly and accurately. It is

especially good at comparing different system types and operating parameters. Contact your local Daikin Applied sales office for assistance on your particular application.

## Evaporator

### **Evaporator temperature drop**

The industry standard has been a ten-degree temperature drop in the evaporator. Increasing the drop to 12 or 14 degrees will improve the evaporator heat transfer, raise the suction pressure, and improve chiller efficiency. Chilled water pump energy will also be reduced.

### **Higher leaving chilled water temperatures**

Warmer leaving chilled water temperatures will raise the compressor's suction pressure and decrease the lift, improving efficiency. Using 45° F (7.0° C) leaving water instead of 42° F (5.5° C) will make a significant improvement.

## Condenser

### **Condenser entering water temperature**

As a general rule, a one-degree drop in condenser entering water temperature will reduce chiller energy consumption by two percent. Cooler water lowers the condensing pressure and reduces compressor work. One or two degrees can make a noticeable difference. The incremental cost of a larger tower can be small and provide a good return on investment.

### **Minimum Condenser Water Temperature Operation**

When ambient wet bulb temperatures are lower than design, the condenser water temperature can be allowed to fall. Lower temperatures will improve chiller performance.

Depending on local climatic conditions, using the lowest possible entering condenser water temperature may be more costly in total system power consumed than the expected savings in chiller power would suggest, due to the excessive fan power required.

Cooling tower fans must continue to operate at 100% capacity at low wet bulb temperatures. As chillers are selected for lower kW per ton, the cooling tower fan motor power becomes a higher percentage of the total peak load chiller power. Daikin's Energy Analyzer® 3 program can optimize the chiller/tower operation for specific buildings in specific locales.

Even with tower fan control, some form of water flow control, such as tower bypass, is recommended.

### **Condenser water temperature rise**

The industry standard of 3 gpm/ton or about a 9.5-degree delta-T works well for most applications. Reducing condenser water flow to lower pumping energy will increase the water temperature rise, resulting in an increase in the compressor's condensing pressure and energy consumption. This is usually not a productive strategy.

## System analysis

Although Daikin is a proponent of analyzing the entire system, it is generally effective to place the chiller in the most efficient mode because it is, by far, a larger energy consumer than pumps. The Daikin Energy Analyzer® 3 program is an excellent tool to investigate the entire system efficiency, quickly and accurately. It is especially good at comparing different system types and operating parameters. Utility costs, load factors, maintenance costs, cost of capital, tax bracket; essentially all factors affecting owning cost, must be considered as well. Generally, the attempts to save the last few full load kW are very costly. For example, the cost to go from 0.58 to 0.57 kW/ton could be significant because of the large number of copper tubes that would have to be added to the heat exchangers. Contact your local Daikin sales representative for assistance on your particular application.

## Mixing Single and Dual Compressor Chillers

WDC dual compressor chillers excel at part load operation, while single compressor chillers usually have better full load efficiency. A good chiller plant strategy is to install one dual and one or more single compressor units. Run the dual until it is fully loaded, then switch to the single compressor unit and run it only at full load, using the dual to trim the load.

## Series Counterflow and Series Parallel Chillers

The design of piping systems can greatly impact chiller performance. A popular system is to place the evaporators in series with the chilled water flowing from one evaporator to the next as shown. Two different condenser water piping arrangements can be used. Parallel flow ([Figure 8](#)) divides the total condenser flow between the two condensers. The counterflow system ([Figure 9](#)) puts all of the condenser water through the condenser of the lag chiller (chiller producing the coldest evaporator leaving water) and then through the lead chiller (chiller seeing the warmest evaporator water temperatures).

Typically, since the lead machine will see the warmest evaporator water, it will have the greater capacity and larger portion of the total system evaporator temperature drop. The lead machine has an 8.4 degree drop (56.0°F-47.6°F) and the lag machine has a 5.6 degree drop (47.6°F - 42.0°F).

Condenser water flow is important to overall system efficiency. With parallel flow, the condensers have identical flow conditions (95 to 85 degrees in this example) with the compressor lift shown. With counterflow arrangement the lift on the lead machine is significantly lower, reducing compressor work and making the overall system efficiency about 2% better. Even though the chiller performance is different, it is good practice to use the same chiller models.

Both the WSC and WDC chillers are suitable for series counterflow arrangement and include controls specifically designed for series chillers. For more information, please refer to Application guide AG -31-003: Chiller Plant Design. Daikin's



model WCC dual compressor chiller (1000 to 2700 tons) combines counterflow design into one unit.

Figure 8: Series Parallel Flow

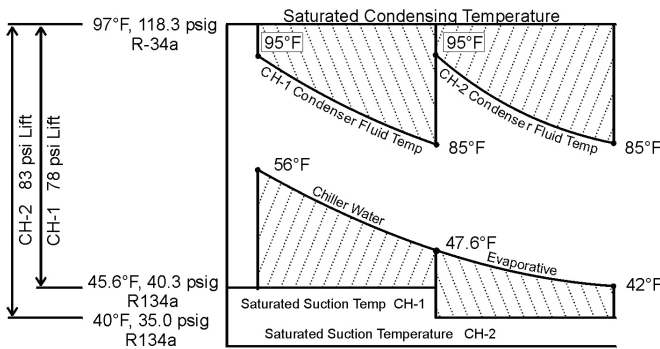
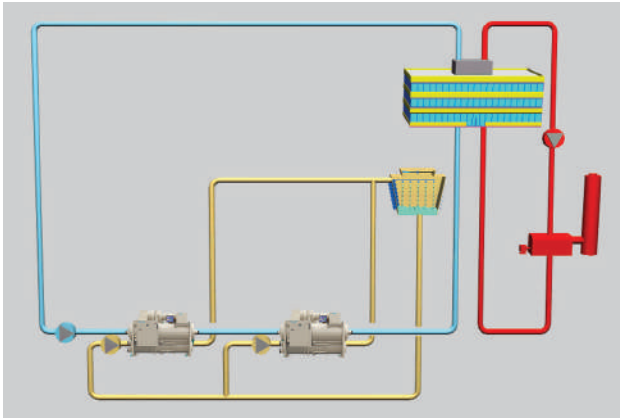
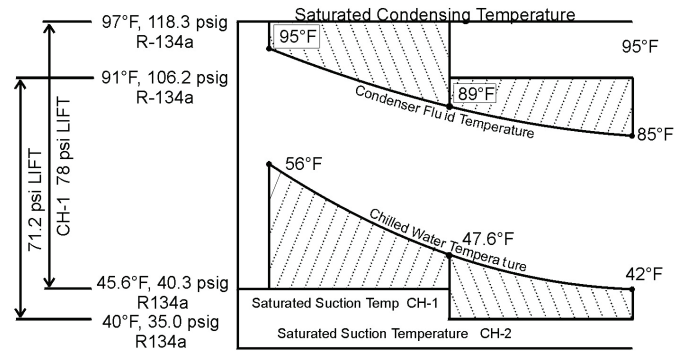
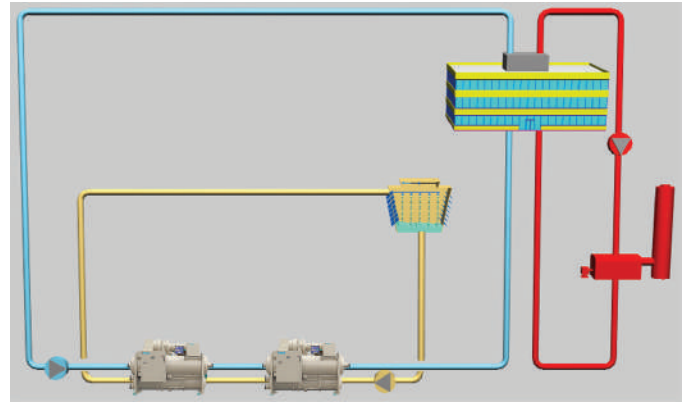

Figure 9: Series Counterflow Flow



## Oil Coolers

Daikin WSC079 to WSC126 model centrifugal chillers have a factory-mounted oil cooler with a temperature controlled water regulating valve and solenoid valve for each compressor. Cooling water connections are located at the rear of the unit, near the compressor and are shown on the specific unit certified drawings. For the WSC160 model, the compressor has an integrated refrigerant cooled oil cooler.

Field water piping to the inlet and outlet connections must be installed according to good piping practices and must include stop valves to isolate the cooler for servicing. A 1" minimum cleanable filter (40 mesh maximum) and drain valve or plug must also be field installed. The water supply for the oil cooler must be from the chilled water circuit, or from an independent clean source such as city water. When using chilled water, it is important that the water pressure drop across the evaporator is greater than the pressure drop across the oil cooler or insufficient oil cooler flow will result. If the pressure drop across the evaporator is less than the oil cooler, the oil cooler must be piped across the chilled water pump, provided that its pressure drop is sufficient. The water flow through the oil cooler will be adjusted by the unit's regulating valve so that the temperature of oil supplied to the compressor bearings (leaving the oil cooler) is between 90°F and 110°F (32°C and 43°C).

**NOTE:** The system must be designed for the highest cooling water temperature possible, which may occur for a short time during startup.

Compressors using chilled water for oil cooling will often start with warm “chilled water” in the system until the chilled water loop temperature is pulled down. With cooling water in the 40°F to 55°F (4°C to 13°C) range, considerably less water will be used and the pressure drop will be greatly reduced. The following table contains oil cooler data at various inlet water temperatures.

**Table 5: WSC Oil Cooler Data**

	Hot Side POE Lube	Cold Side Water				
WSC 079-087						
Flow, gpm	9.9	11.9	2.9	2.0	1.54	
Inlet Temp., °F	118.0	80.0	65.0	55.0	45.0	
Outlet Temp., °F	100.0	87.3	94.5	98.3	101.4	
Pressure Drop, psi	-	4.3	0.3	0.14	0.09	
WSC 100-126						
Flow, gpm	15.8	21.9	5.11	3.5	2.7	
Inlet Temp., °F	120.0	80.0	65.0	55.0	45.0	
Outlet Temp., °F	100.0	87.0	95.0	99.0	102.3	
Pressure Drop, psi	-	3.78	0.23	0.11	0.07	

**Table 6: WSC with VFD Oil Cooler Data**

	Hot Side POE Lube	Cold Side Water				
WSC 079-087						
Flow, gpm	9.9	13.4	4.0	2.9	2.3	
Inlet Temp., °F	118.0	80.0	65.0	55.0	45.0	
Outlet Temp., °F	100.0	90.3	99.6	103.1	105.6	
Pressure Drop, psi	-	30.5	6.7	4.8	3.6	
WSC 100-126						
Flow, gpm	15.8	24.4	7.0	5.0	4.0	
Inlet Temp., °F	120.0	80.0	65.0	55.0	45.0	
Outlet Temp., °F	100.0	89.8	100.1	103.6	106.2	
Pressure Drop, psi	-	30.6	15.7	11.4	9.3	

**NOTE:** Pressure drops include valves on the unit.

When supplied with city water, the oil piping must discharge through a trap into an open drain to prevent draining the cooler by siphoning. The city water can also be used for cooling tower makeup by discharging it into the tower sump from a point above the highest possible water level.

**NOTE:** Particular attention must be paid to chillers with variable chilled water flow through the evaporator. The pressure drop available at low flow rates can very well be insufficient to supply the oil cooler with enough water. In this case an auxiliary booster pump

can be used or city water employed. Cooling Water Connection Sizes WSCs 079-126 are 1 in. FPT.

**Figure 10: WSC Oil Cooler Piping Across Chilled Water Pump (WSC079 to WSC126 models)**

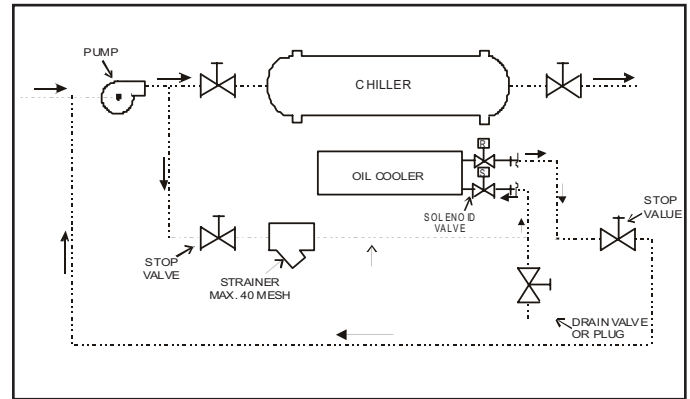

**Figure 11: WSC Oil Cooler Piping With City Water (WSC079 to WSC126 models)**

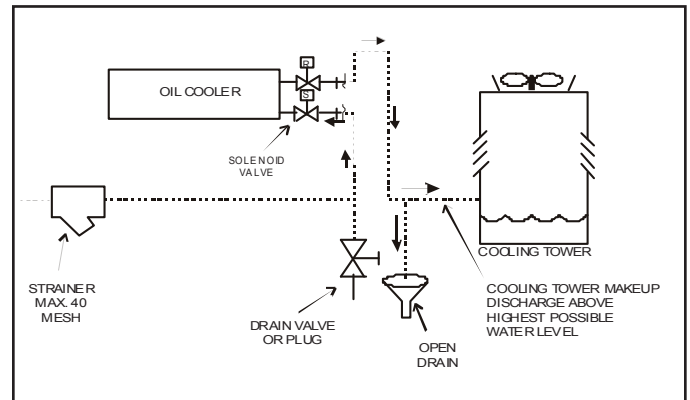

## Pumps

Model WSC chiller compressor motors operate at 3600 rpm on 60 Hz power (3000 rpm on 50 Hz). When VFDs are employed, the hertz/speed can be reduced by 70%. To avoid the possibility of objectionable harmonics in the system piping, 4-pole, 1800/1500 rpm system pumps should be used. The condenser water pump(s) must be cycled off when the last chiller of the system cycles off. This will keep cold condenser water from migrating refrigerant to the condenser. Cold liquid refrigerant in the condenser can make start-up difficult. In addition, turning off the condenser water pump(s) when the chillers are not operating will conserve energy.

Include thermometers and pressure gauges at the chiller inlet and outlet connections and air vents at the high points of piping. The water heads can be interchanged (end for end), allowing water connections to be made at either end of the unit. Use new head gaskets when interchanging water heads. When water pump noise is objectionable, use rubber isolation sections at both the inlet and outlet of the pump. Vibration eliminator sections in the condenser inlet and outlet water lines are not normally required. Where noise and vibration are critical and the unit is mounted on spring isolators, flexible

piping and conduit connections are necessary. If not factory installed, a flow switch or pressure differential switch must be installed in the leaving chilled water line in accordance with the flow switch manufacturer's instructions.

Be sure that water inlet and outlet connections match certified drawings and nozzle markings. All evaporators and condensers have OGS-type grooved water connections (adhering to Standard AWWA C606) or optional flange connections. The installing contractor must provide matching mechanical connections. PVC piping should not be used.

## Filtering and Treatment

Owners and operators must be aware that if the unit is operating with a cooling tower, cleaning and flushing the cooling tower is required. Ensure tower blow-down or bleed-off is operating. Atmospheric air contains many contaminants, which increases the need for water treatment. The use of untreated water will result in corrosion, erosion, slime buildup, scaling, or algae formation. A water treatment service should be used. Daikin is not responsible for damage or faulty operation from untreated or improperly treated water.

## Machine Room Ventilation

In the market today, centrifugal chillers are available with either hermetic or open type motors. Hermetic motors are cooled with refrigerant and dissipate their heat through the cooling tower. On the other hand, open motors circulate equipment room air across themselves for cooling and reject the heat to the equipment room. Daikin chillers have hermetic motors and DO NOT require additional ventilation.

For chillers with open-drive type, air-cooled motors, good engineering practice dictates that the motor heat be removed to prevent high equipment room temperatures. In many applications this requires a large volume of ventilation air, or mechanical cooling to properly remove this motor heat.

EXAMPLE: 1000 tons x 0.6 kW/Ton x 0.04 motor heat loss x 0.284 Tons/kW = 7 tons (24 kW) cooling

The energy and installation costs of ventilation or mechanical cooling equipment must be considered when evaluating various chillers. For a fair comparison, the kW used for the ventilation fans, or if mechanical cooling is required, the additional cooling and fan energy must be added to the open motor compressor energy when comparing hermetic drives. Additionally, significant costs occur for the purchase, installation, and maintenance of the ventilation or air handling units.

Equipment room ventilation and safety requirements for various refrigerants is a complex subject and is updated from time to time. The latest edition of ASHRAE 15 should be consulted.

## Thermal Storage

Daikin chillers are designed for use in thermal storage systems. The chillers have two operating conditions that must be considered. The first is normal air-conditioning duty where leaving evaporator fluid temperatures range from 40°F to 45°F

(4.4°C to 7.2°C). The second condition occurs during the ice making process when leaving fluid temperatures are in the 22°F to 26°F (-5.6°C to -3.3°C) range.

The MicroTech® II control system will accommodate both operating points. The ice mode can be started or stopped by an input signal to the microprocessor from a BAS or through a chilled water reset signal. When a signal is received to change from the ice mode to the normal operating mode, the chiller will shut down until the system fluid temperature rises to the higher setpoint. The chiller will then restart and continue operation at the higher leaving fluid temperature. When changing from normal cooling to the ice mode, the chiller will load to maximum capacity until the lower setpoint is reached.

Computer selections must be made to check that the chiller will operate at both conditions. If the "ice mode" is at night, the pressure differentials between the evaporator and condenser are usually similar to normal cooling applications. The leaving fluid temperature is lower, but the condensing temperature is also lower because the cooling tower water is colder. If the ice mode can also operate during the day, when cooling tower water temperatures are high, a proper selection becomes more difficult because the two refrigerant pressure differentials are significantly different.

A three-way condenser water control valve is always required.

## Variable Speed Pumping

Variable speed pumping involves changing system water flow relative to cooling load changes. Daikin centrifugal chillers are designed for this duty with two limitations.

First, the rate of change in the water flow needs to be slow, not greater than 10% of the change per minute. The chiller needs time to sense a load change and respond.

Second, the water velocity in the vessels must be 3 to 10 fps (0.91 and 3.0 m/sec). Below 3 fps (0.91 m/sec), laminar flow occurs which reduces heat transfer. Above 10 fps (3.0 m/sec), excessively high pressure drops and tube erosion occur. These flow limits can be determined from the Daikin selection program.

We recommend variable flow only in the evaporator because there is virtually no change in chiller efficiency compared to constant flow. In other words, there is no chiller energy penalty. Although variable speed pumping can be done in the condenser loop, it is usually unwise. The intent of variable flow is to reduce pump horsepower. However, reducing condenser water flow increases the chiller's condensing pressure, increasing the lift that the compressor must overcome which, in turn, increases the compressor's energy use. Consequently, pump energy savings can be lost because the chiller operating power is significantly increased.

Low condenser flow can cause premature tube fouling and subsequent increased compressor power consumption. Increased cleaning and/or chemical use can also result.

## System Water Volume

All chilled water systems need adequate time to recognize a load change, respond to that load change and stabilize, without

undesirable short cycling of the compressors or loss of control. In air conditioning systems, the potential for short cycling usually exists when the building load falls below the minimum chiller plant capacity or on close-coupled systems with very small water volumes.

Some of the things the designer should consider when looking at water volume are the minimum cooling load, the minimum chiller plant capacity during the low load period and the desired cycle time for the compressors.

Assuming that there are no sudden load changes and that the chiller plant has reasonable turndown, a rule of thumb of “gallons of water volume equal to two to three times the chilled water gpm flow rate” is often used.

A properly designed storage tank should be added if the system components do not provide sufficient water volume.

### Vibration Mounting

Every Daikin chiller is run tested and compressor vibration is measured and limited to a maximum rate of 0.14 inches per second, which is considerably more stringent than other available compressors. Consequently, floor-mounted spring isolators are not usually required. Rubber mounting pads are shipped with each unit. It is wise to continue to use piping flexible connectors to reduce sound transmitted into the pipe and to allow for expansion and contraction.

### AHRI Standard 575 Sound Ratings

Sound data in accordance with AHRI Standard 575 for individual units are available from your local Daikin representative. Due to the large number of component combinations and variety of applications, sound data is not included in this catalog.

### Glycol Operation

The addition of glycol to the chilled water system for freeze protection can be required for special applications.

### Certifications and Standards

As with many other Daikin Applied chiller products, the centrifugal chiller models meet all necessary certifications and standards.

### AHRI Certification

AHRI Standard 550/590 for Water-Chilling and Heat Pump Water-Heating Packages Using the Vapor Compression Cycle defines certification and testing procedures and performance tolerances of all units that fall within the scope of the standard.

Full AHRI 550/590 participation and certification is an on-going commitment at Daikin. Daikin centrifugal chillers are rated and certified in accordance with the latest edition of AHRI Standard 550/590. The AHRI label affixed to units certifies that the unit will meet the specified performance.

Daikin SelectTools (DST) for Centrifugal Chillers is used to select and rate chillers for specific job conditions. The program

version number and issue date are listed in the AHRI Directory of Certified Applied Air-Conditioning Products available at [www.ahridirectory.org](http://www.ahridirectory.org). DST ratings are available from your local Daikin Applied sales representative.

Part load performance can be presented in terms of Integrated Part Load Value (IPLV) or Non-Standard Part Load Values (NPLV), both of which are defined by AHRI Standard 550/590. Based on this standard, and as shown in the figure below, a typical chiller can operate up to 99% of the time at off-peak conditions and usually spends most of this time at less than 60% of design capacity.

**Figure 12: IPLV Defined by AHRI Standard 550/590**

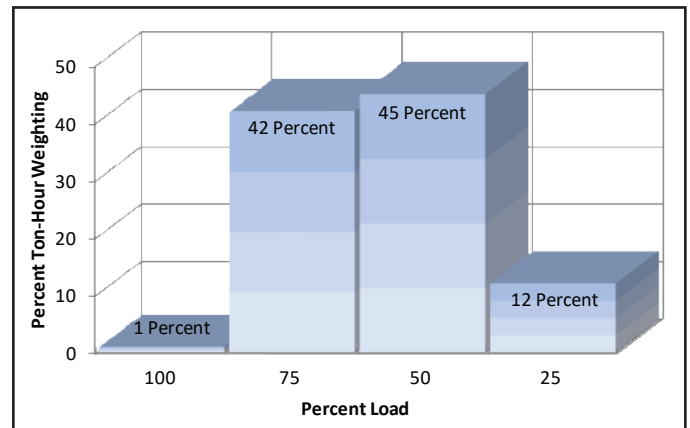

### Compliance with ASHRAE Std.90.1

ASHRAE Standard 90.1 was developed to assist owners and designers in making informed choices on a building’s design, systems, and equipment selection. Daikin centrifugal chillers can significantly exceed ASHRAE 90.1 minimum efficiency requirements.

### LEED®

For building owners who wish to pursue Leadership in Energy and Environmental Design (LEED®) Green Building Certification, the performance of the WWV may contribute points towards Energy and Atmosphere (EA) Credits.

Points earned for Optimize Energy Performance (formerly EA Credit 1) are awarded based on overall building efficiency. The high efficiency of the WWV will contribute to the total points earned for this credit. Enhanced Refrigerant Management (formerly EA Credit 4) qualification is partially determined by tonnage and refrigerant quantity. Vessel stack and tube count selections will affect the quantity of refrigerant in the chiller.

Consult with your Daikin Applied sales representative for more information.

## Relief Valves

Relief valve connection sizes are 1-inch FPT, with a relief valve (3/8 inch flare) on the top of the oil sump of all units.

All relief valves (including the oil sump) must be piped to the outside of the building in accordance with ANSI/ASHRAE 15- 2001. The new 2001 standard has revised the calculation method compared to previous issues.

Twin relief valves, mounted on a transfer valve, are used on the condenser so that one relief valve can be shut off and removed for testing or replacement, leaving the other in operation. Only one of the two valves is in operation at any time. Where four valves are shown, on some large vessels, they consist of two relief valves mounted on each of two transfer valves. Only two relief valves of the four are active at any time.

- Note: some large condensers have 4 relief valves

Since the pressures and valve size are fixed for Daikin chillers, the ASHRAE equation can be reduced to the simple table shown below.

**NOTE:** A 1-inch pipe is too small to handle these valves. A pipe increaser must be installed at the valve outlet.

Per ASHRAE Standard 15, the pipe size cannot be less than the relief device. The discharge from more than one relief valve can be run into a common header, the area of which shall not be less than the sum of the areas of the connected pipes. For further details, refer to ASHRAE Standard 15.

The above information is a guide only. Consult local codes and/or latest version of ASHRAE Standard 15 for sizing data.

Figure 13: Typical Vent Piping

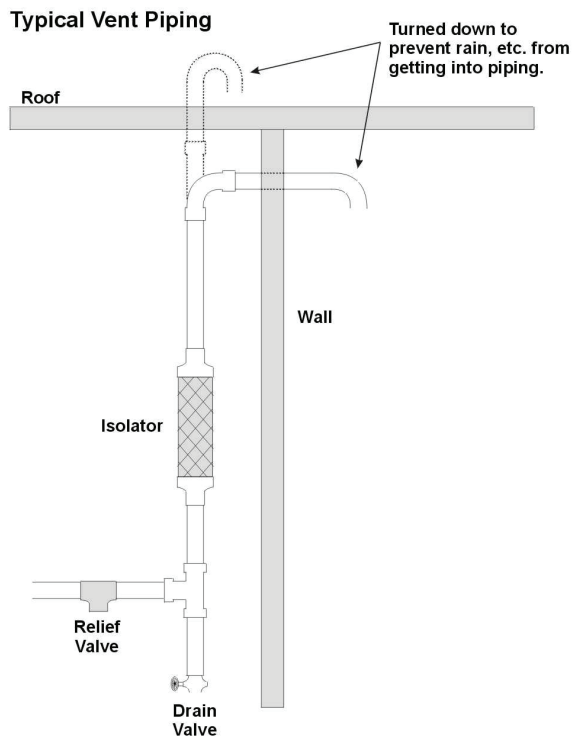

Vent piping is sized for only one valve of the set since only one can be in operation at a time.

### Relief Pipe Sizing (ASHRAE Method)

Relief valve pipe sizing is based on the discharge capacity for the given evaporator or condenser and the length of piping to be run.

Daikin centrifugal chillers have the following relief valve settings and discharge capacity:

- WSC evaporator (1 valve) and condenser (2 valves piped together to common vent pipe) = 200 psi, 75.5 lb of air/min

## CENTRIFUGAL CHILLERS (WSC 079-126)

### PART 1 — GENERAL

#### 1.1 SUMMARY

- A. Section includes design, performance criteria, refrigerants, controls, and installation requirements for water-cooled centrifugal chillers.

#### 1.2 REFERENCES

A Comply with the following codes and standards

1. AHRI 550/590
2. NEC
3. ANSI/ASHRAE 15
4. OSHA as adopted by the State
5. ASME Section VIII

#### 1.3 SUBMITTALS

A Submittals shall include the following:

1. Dimensioned plan and elevation view drawings, including motor starter cabinet, required clearances, and location of all field piping and electrical connections.
2. Summaries of all auxiliary utility requirements such as: electricity, water, air, etc. Summary shall indicate quality and quantity of each required utility.
3. Diagram of control system indicating points for field interface and field connection. Diagram shall fully depict field and factory wiring.
4. Manufacturer's certified performance data at full load plus IPLV or NPLV.
5. Before shipment, submit a certification of satisfactory completion of factory run test signed by a company officer. The test shall be conducted according to AHRI Standard 550/590.
6. Installation and Operating Manuals.

#### 1.4 QUALITY ASSURANCE

- A. Qualifications: Equipment manufacturer must specialize in the manufacture of the products specified and have five years experience with the equipment and refrigerant offered.
- B. Regulatory Requirements: Comply with the codes and standards in Section 1.2.
- C. Chiller manufacturer plant shall be ISO Registered.

#### 1.5 DELIVERY AND HANDLING

- A. Chillers shall be delivered to the job site completely assembled and charged with refrigerant and oil.
- B. Comply with the manufacturer's instructions for rigging

and transporting units. Leave protective covers in place until installation.

#### 1.6 WARRANTY

- A. The refrigeration equipment manufacturer's warranty shall be for a period of (one) -- OR -- (two) --Or-- (five) years from date of equipment start up or 18 months from shipment whichever occurs first. The warranty shall include parts and labor costs for the repair or replacement of defects in material or workmanship.

#### 1.7 MAINTENANCE

- A. Chiller maintenance shall be the responsibility of the owner with the following exceptions:
  1. The manufacturer shall provide the first year scheduled oil and filter change if required.
  2. The manufacturer shall provide first year purge unit maintenance if required.

### PART 2 — PRODUCTS

#### 2.1 ACCEPTABLE MANUFACTURERS

- A. Daikin
- B. (Approved Equal)

#### 2.2 UNIT DESCRIPTION

- A. Provide and install as shown on the plans a factory-assembled, factory charged water-cooled packaged chiller. Each unit shall be complete with a single-stage semi-hermetic centrifugal compressor with lubrication and control system, factory mounted starter, evaporator, condenser, refrigerant control device and any other components necessary for a complete and operable chiller package.
- B. Each chiller shall be factory run-tested under load conditions for a minimum of one hour on an AHRI approved test stand with evaporator and condenser waterflow at job conditions (excluding glycol applications). Operating controls shall be adjusted and checked. The refrigerant charge shall be adjusted for optimum operation and recorded on the unit nameplate. Any deviation in performance or operation shall be remedied prior to shipment and the unit retested if necessary to confirm repairs or adjustments. Manufacturer shall supply a certificate of completion of a successful run-test upon request.
- C. Electrical components shall be housed in NEMA 1 enclosures, designed for clean, indoor locations.

#### 2.3 DESIGN REQUIREMENTS

- A. General: Provide a complete water-cooled semi-hermetic

centrifugal compressor water-chilling package as specified herein. Machine shall be provided according to referenced standards Section 1.2. In general, unit shall consist of a compressor, condenser, evaporator, lubrication system, starter and control system.

**NOTE:** Chillers shall be charged with a refrigerant such as R-134a, not subject to the Montreal Protocol and the U. S. Clean Air Act.

- B. Performance: Refer to schedule on the drawings. The chiller shall be capable of stable operation to ten percent of full load with standard AHRI entering condensing water relief without the use of hot gas bypass.
- C. Seismic Certification:
  - 1. Chiller shall be certified to IBC 2009.
  - 2. Chiller shall be OSHPD Pre-Approved. Chiller to meet a minimum seismic response factor of 1.60 SDS. Chiller shall be installed as rigid base mounted only or with RIS isolators as these configurations are inherently more stable than spring mounted installations for seismic applications.
- D. Acoustics: Sound pressure levels for the complete unit shall not exceed the following specified levels. Provide the necessary acoustic treatment to chiller as required. Sound data shall be measured according to AHRI Standard 575. Data shall be in dB. Data shall be the highest levels recorded at all load points. Test shall be in accordance with AHRI Standard 575.

## 2.4 CHILLER COMPONENTS

- A. Compressor:
  - 1. Unit shall have a single-stage semi-hermetic centrifugal compressor. Casing design shall ensure major wearing parts, main bearings, and thrust bearings are accessible for maintenance and replacement. The lubrication system shall protect machine during coast down period resulting from a loss of electrical power.
  - 2. Impeller shall be statically and dynamically balanced. The compressor shall be vibration tested and not exceed a level of 0.14 IPS.
  - 3. Movable inlet guide vanes actuated by an internal oil pressure driven piston shall accomplish unloading. Compressors using an unloading system that requires penetrations through the compressor housing or linkages, or both that must be lubricated and adjusted are acceptable provided the manufacturer provides a five-year inspection agreement consisting of semi-annual inspection, lubrication, and annual change out of any compressor seals. A statement of inclusion must accompany any quotations.
  - 4. If compressor is not equipped with guide vanes for each stage and movable discharge diffusers, then furnish hot gas bypass and select chillers at 5% lower kW/ton than specified to compensate for bypass inefficiency at low loads.
  - 5. For open motor units, an oil reservoir shall collect

any oil and refrigerant that leaks past the seal. A float device shall be provided to open when the reservoir is full, directing the refrigerant/oil mixture back into the compressor housing.

- 6. Manufacturer shall warrant the shaft seal, reservoir, and float valve system against leakage of oil and refrigerant to the outside of the refrigerating unit for a period of 5 years from the initial start-up including parts and labor to replace a defective seal and any refrigerant required to trim the charge original specifications.
- B. Lubrication System: Each compressor shall have an independent lubrication system to provide lubrication to all parts requiring oil. Provide a heater in the oil sump to maintain oil at sufficient temperature to minimize affinity of refrigerant, and a thermostatically controlled water-cooled oil cooler. Coolers located inside the evaporator or condenser are not acceptable due to inaccessibility. A positive displacement oil pump shall be powered through the unit control transformer.
- C. Refrigerant Evaporator and Condenser:
  - 1. Evaporator and condenser shall be of the shell-and-tube type, designed, constructed, tested and stamped according to the requirements of the ASME Code, Section VIII. Regardless of the operating pressure, the refrigerant side of each vessel will bear the ASME stamp indicating compliance with the code and indicating a test pressure of 1.1 times the working pressure, but not less than 100 psig. Provide intermediate tube supports at a maximum of 24 inch spacing.
  - 2. Tubes shall be enhanced for maximum heat transfer, rolled into steel tube sheets and sealed with Locktite. or equal sealer. The tubes shall be individually replaceable
  - 3. Provide sufficient isolation valves and condenser volume to hold the full unit refrigerant charge in the condenser during servicing or provide a separate pumpout system and storage tank sufficient to hold the charge of the largest unit being furnished.
  - 4. The water sides shall be designed for a minimum of 150 psi or as specified elsewhere. Vents and drains shall be provided.
  - 5. An electronic refrigerant expansion valve shall control refrigerant flow to the evaporator. Fixed orifice devices or float controls with hot gas bypass are not acceptable because of inefficient control at low load conditions. The liquid line shall have a moisture indicating sight glass.
  - 6. Reseating type spring loaded pressure relief valves according to ASHRAE-15 safety code shall be furnished. The evaporator shall be provided with single or multiple valves. The condenser shall be provided with dual relief valves equipped with a transfer valve so one valve can be removed for testing or replacement without loss of refrigerant or removal of refrigerant from the vessel. Rupture disks are not acceptable.
  - 7. The evaporator, suction line, and any other component or part of a component subject to condensing moisture shall be insulated with UL recognized 3/4 inch closed cell

insulation, with an option for double insulation. All joints and seams shall be carefully sealed to form a vapor barrier.

8. Provide factory-mounted thermal dispersion flow switches on each vessel to prevent unit operation with no flow.

**D. Motor**

1. Squirrel cage induction motor of the semi-hermetic type of sufficient size to efficiently fulfill compressor horsepower requirements. Motor shall be liquid refrigerant cooled with internal thermal overload protection devices embedded in the winding of each phase. Motor shall be compatible with the starting method specified hereinafter. If the Contractor chooses to provide an open drive motor or compressor, verify in the submittal that the scheduled chiller room ventilation system will accommodate the additional heat and maintain the equipment room at design indoor temperature based on 95.F outdoor ambient ventilation air available. If additional cooling is required, manufacturer shall be responsible for the installation, wiring and controls of a cooling system. Chiller selection shall compensate for tonnage and efficiency loss to make certain the owner is not penalized.

**E. Motor Starter:**

1. The main motor starter is to be factory mounted and fully wired to the chiller components and factory tested during the run test of the unit.

**-- OR -**

The main motor starter is to be furnished by the chiller manufacturer and shipped loose for floor mounting and field wiring to the chiller package. It shall be free-standing with NEMA-1 enclosure designed for top entry and bottom exit and with front access.

2. For open drive air-cooled motors the chiller manufacturer shall be responsible for providing the cooling of the refrigeration machinery room. The sensible cooling load shall be based on the total heat rejection to the atmosphere from the refrigeration units.
3. The starter must comply with the codes and standards in Section 1.2.
4. **Low Voltage (200 through 575 volts)** controllers are to be continuous duty AC magnetic type constructed according to NEMA standards for Industrial Controls and Systems (ICS) and capable of carrying the specified current on a continuous basis. The starters shall be:

Solid-State Reduced Voltage - Starters shall be furnished with silicon controlled rectifiers (SCR) connected for starting and include a bypass contactor. When operating speed is reached, the bypass contactor shall be energized removing the SCRs from the circuit during normal running.

- a. All starters shall be coordinated with the chiller package(s) making certain all terminals are properly marked according to the chiller manufacturer's wiring diagrams.

- b. The starters shall be equipped with redundant motor control relays (MCR). The relays shall interconnect the starters with the unit control panels and directly operate the main motor contactors. The MCRs shall constitute the only means of energizing the motor starter.
- c. The main contactors shall have a normally open auxiliary contact rated at 125VA pilot duty at 115 VAC. An additional set of normally open contacts shall be provided for each MCR.
- d. There shall be electronic overloads in each phase which will permit continuous operation at 107% of the rated load amps of each motor. The overloads shall have a must-trip setting at 125% of the RLA. Overloads shall be manual reset and shall de-energize the main contactors when the overcurrent occurs. The overloads shall be adjustable and selected for midrange. Overloads shall be adjustable, manual reset, ambient compensated, and set for class 10 operation.
- e. Each starter shall have a current transformer and adjustable voltage dropping resistor(s) to supply a 5.0 VAC signal at full load to the unit control panels.
- f. Each starter shall be equipped with a line to 115 VAC control transformer, fused in both the primary and secondary, to supply power to the control panels, oil heaters and oil pumps.
- g. Each starter shall include phase under/over voltage protection, phase failure and reversal protection, a load break disconnect switch and current limiting power fuses.

**-- OR -**

Variable Frequency Drive

- a. The chiller shall be equipped with an air-cooled Variable Frequency Drive (VFD) to automatically regulate each compressor speed in response to cooling load and compressor pressure lift requirement. Liquid cooling is unacceptable. If a condenser water-cooled VFD is supplied, the manufacturer shall supply factory installed dual water filters with a bypass valve and pressure differential switch factory wired to the chiller control panel to indicate that a filter has clogged and requires service. The pressure differential switch shall also provide a separate dry contact which can be connected to the BAS system as a means of notifying operating personnel of the need to service the filters. If the condenser cooling circuit includes an intermediate heat exchanger, it must be of the brush cleanable shell and tube style. Braze plate heat exchangers which cannot be field cleaned are not acceptable. Movable inlet guide vanes and variable compressor speed shall provide unloading. The chiller controls shall coordinate compressor speed and guide vane position to



optimize chiller efficiency.

-- OR -

**4 Medium Voltage (2400 through 6600 volts).** The starter shall be:

Solid-State Reduced Voltage - Starter shall be furnished with silicon controlled rectifiers (SCR) connected for starting and include a bypass contactor. When operating speed is reached, the bypass contactor shall be energized removing the SCRs from the circuit during normal running.

- a. The starter shall be coordinated with the chiller package(s) making certain all terminals are properly marked according to the chiller manufacturer's wiring diagrams.
- b. The starters shall be equipped with redundant motor control relays (MCR). The relays shall interconnect the starters with the unit control panels and directly operate the main motor contactors. The MCRs shall constitute the only means of energizing the motor contacts.
- c. The main contactors shall have a normally-open auxiliary contact rated at 125VA pilot duty at 115 VAC. An additional set of normally open contacts shall be provided on the MCR.
- d. There shall be electronic overloads in each phase which will permit continuous operation at 107% of the rated load amps of each motor. Overloads shall be manual reset and shall de-energize the main contactors when the overcurrent occurs. The overloads shall be adjustable and selected for midrange. Overloads shall be adjusted for a locked rotor trip time of 8 seconds at full voltage and must trip in 60 seconds or less at reduced voltage (33% of delta LRA).
- e. Each starter shall have a current transformer and adjustable voltage dropping resistor(s) to supply a 5.0 VAC signal at full load to the unit control panels.
- f. Each starter shall be equipped with a line-to-115 VAC control transformer, fused in both the primary and secondary, to supply power to the control panels, oil heaters and oil pumps.
- g. Each starter shall include phase under/over voltage protection, phase failure and reversal protection, a load break disconnect switch and current limiting power fuses

-- OR -

Across-the-Line type with primary contactor allowing locked rotor amps to reach the motor when energized and including items a through g above.

All medium and higher voltage starters shall have the following components:

### 1. Main Control Relays

A motor control relay shall be provided to interlock the starter

with the chiller. The relay shall constitute the only means of energizing the motor starter. No other devices (manual or automatic) with the capability of energizing the starter can be used. The starter is to be controlled by the unit microprocessor.

### 2. Motor Protection and Overloads

The starter shall include overload protection functions. These controls include:

- Solid state overload (overcurrent) protection
- Phase unbalance protection
- Phase reversal and phase loss protection.
- Adjustable overload to closely match motor performance
- Three current transformers to measure motor current and a fourth current transformer for input to the chiller microprocessor.

### 3. Undervoltage (UV) Relay

The undervoltage relay is an adjustable three-phase protection system that is activated when the voltage falls below a predetermined safe value and is factory set at 85% of nominal.

### 4. Control Voltage Transformer

The starter is to be provided with a 3KVA control transformer with both secondary and primary fuses to supply control power to the chiller.

### 5. Additional Standard Components

- Mechanical type solderless connectors to handle wire sizes indicated by NEC.
- Three isolated vertical line contactors
- Three-pole, gang operated non-load break isolating switch
- Three vertically mounted current limiting power fuse blocks (fuses included)
- Magnetic three-pole, vacuum break contactor
- Single phase control circuit transformer
- Vertically mounted control circuit primary current limiting fuses
- Current transformers
- Control circuit terminal blocks and secondary fuses
- Phase failure and reversal relay

### F. CHILLER CONTROLLER

Control enclosures shall be NEMA 1. The chiller shall have distributed control consisting of a unit controller, a compressor controller and a 15-inch super VGA color touch screen for operator interface with the control system.

The touch screen shall have graphics clearly depicting the chiller status, operating data, including water temperatures, percent RLA, water setpoint, alarm status and have STOP and AUTO control buttons.

The operator interface touch screen shall have inherent trend logging capabilities, which are transferable to other PC management systems such as an Excel spreadsheet via a USB port. Active trend logging data shall be available for viewing in 20 minute, 2 hour or 8 hour intervals. A full 24 hours of history is downloadable via a USB port. The following

trended parameters shall be displayed:

- Entering and leaving chilled water temps
- Entering and leaving condenser water temps
- Evaporator saturated refrigerant pressure
- Condenser saturated refrigerant pressure
- Net oil pressure
- % rated load amps

In addition to the trended items above, other real-time operating parameters are also shown on the touch screen. These items can be displayed in two ways: by chiller graphic showing each component or from a color-coded, bar chart format. At a minimum, the following critical areas must be monitored:

- Oil sump temperature
- Oil feed line temperature
- Evaporator saturated refrigerant temperature
- Suction temperature
- Condenser saturated refrigerant temperature
- Discharge temperature
- Liquid line temperature

Unit setpoints shall be viewable on screens and changeable after insertion of a password. Complete unit operating and maintenance instructions shall be viewable on the touch screen and be downloadable via an onboard USB port. Complete fault history shall be displayed using an easy to decipher, color coded set of messages that are date and time stamped. The last 20 faults shall be downloadable from the USB port.

Automatic corrective action to reduce unnecessary cycling shall be accomplished through pre-emptive control of low evaporator or high discharge pressure conditions to keep the unit operating through ancillary transient conditions. System specific, chiller plant architecture software shall be employed to display the chiller, piping, pumps and cooling tower. Multi-chiller interconnection software for up to 4 WSC, WCC or WDC chillers shall be included also providing automatic control of: evaporator and condenser pumps (primary and standby), up to 4 stages of cooling tower fans and a cooling tower modulating bypass valve and/or cooling tower fan variable frequency drives. There shall be five possible tower control strategies:

1. Tower fan staging only – up to 4 stages controlled by either the entering condenser water temperature or lift differential temperature between the condenser and evaporator saturated temperatures.
2. Tower fan staging plus low limit - controlled as in # 1 plus tower bypass valve set at a minimum entering condenser water temperature
3. Tower staging with staged bypass control – similar to # 2 with additional control of the bypass valve between fan staging to smooth control and minimize fan staging.
4. VFD staging only – in this mode, a variable speed drive controls the first fan with up to 3 more fans to be staged on and off and there is no bypass valve.
5. VFD and Valve Staging – same as # 4 plus bypass valve control

Factory mounted DDC controller(s) shall support operation on a BACnet®, Modbus® or LONMARKS® network via one of the data link / physical layers listed below as specified by the successful Building Automation System (BAS) supplier.

- BACnet MS/TP master (Clause 9)
- BACnet IP, (Annex J)
- BACnet ISO 8802-3, (Ethernet)
- LONMARKS FTT-10A. The unit controller shall be LONMARKS® certified.

The information communicated between the BAS and the factory mounted unit controllers shall include the reading and writing of data to allow unit monitoring, control and alarm notification as specified in the unit sequence of operation and the unit points list. eXternal Interface File (XIF) shall be provided with the chiller submittal data. All communication from the chiller unit controller as specified in the points list shall be via standard BACnet objects. Proprietary BACnet objects shall not be allowed. BACnet communications shall conform to the BACnet protocol (ANSI/ASHRAE 135-2001). A BACnet Protocol Implementation Conformance Statement (PICS) shall be provided along with the unit submittal.

## 2.5. MISCELLANEOUS ITEMS

- A. Pumpout System: If the design of the unit does not allow the charge to be transferred to and isolated in the main condenser, it shall be equipped with an ASME pumpout system complete with a transfer pump, condensing unit, and storage vessel . The main condenser shall be sized to contain the refrigerant charge at 90.F according to ANSI-ASHRAE 15.A.
- B. Purge System (Negative Pressure Chillers Only):
  1. The chiller manufacturer shall provide a separate high efficiency purge system that operates independently of the unit and can be operated while the unit is off. The system shall consist of an air-cooled condensing unit, purge condensing tank, pumpout compressor and control system.
  2. A dedicated condensing unit shall be provided with the purge system to provide a cooling source whether or not the chiller is running. The condensing unit shall provide a low purge coil temperature to result in a maximum loss of 0.1 pounds of refrigerant per pound of purged air.
  3. The purge tank shall consist of a cooling coil, filter-drier cores, water separation tube, sight glass, drain, and air discharge port. Air and water are separated from the refrigerant vapor and accumulated in the purge tank.
  4. The pumpout system shall consist of a small compressor and a restriction device located at the pumpout compressor suction connection.
  5. The purge unit shall be connected to a 100% reclaim device.
- C. Vacuum Prevention System (negative pressure chillers only): Chiller manufacturer shall supply and install a vacuum prevention system for each chiller. The system shall constantly maintain 0.05 psig inside the vessel during non-operational periods. The system shall consist of a

precision pressure controller, two silicon blanket heaters, a pressure transducer, and solid-state safety circuit.

D. Refrigerant Detection Device (negative pressure chillers only): Chiller manufacturer shall supply and install a refrigerant detection device and alarm capable of monitoring refrigerant at a level of 10 ppm. Due to the critical nature of this device and possible owner liability, the chiller manufacturer shall guarantee and maintain the detection monitor for five years after owner acceptance of the system.

E. Waffle type vibration pads for field mounting under unit feet.

F. IBC Certification: The chiller shall be certified to the following codes and standards; 2009 IBC, 2010 CBC, ICC-ES AC-156, ASCE 7-05. The chiller must be mounted to a rigid base and may use neoprene waffle vibration pads.

## PART 3 — EXECUTION

### 3.1 INSTALLATION

- A. Install according to manufacturer's requirements, shop drawings, and Contract Documents.
- B. Adjust chiller alignment on concrete foundations, sole plates or subbases as called for on drawings.
- C. Arrange the piping on each vessel to allow for dismantling the pipe to permit head removal and tube cleaning.
- D. Furnish and install necessary auxiliary water piping for oil cooler.
- E. Coordinate electrical installation with electrical contractor.
- F. Coordinate controls with control contractor.
- G. Provide all material required to ensure a fully operational and functional chiller.

### 3.2 START-UP

- A. Units shall be factory charged with the proper refrigerant and oil.
- B. Factory Start-Up Services: The manufacturer shall provide factory authorized supervision for as long a time as is necessary to ensure proper operation of the unit, but in no case for less than two full working days. During the period of start-up, the start-up technician shall instruct the owner's representative in proper care and operation of the unit.

## CENTRIFUGAL CHILLERS (WSC 160)

### PART 1 — GENERAL

#### 1.1 SUMMARY

- A. Section includes design, performance criteria, refrigerants, controls, and installation requirements for water-cooled centrifugal chillers.

#### 1.2 REFERENCES

A Comply with the following codes and standards

1. AHRI 550/590
2. NEC
3. ANSI/ASHRAE 15
4. OSHA as adopted by the State
5. ASME Section VIII

#### 1.3 SUBMITTALS

A Submittals shall include the following:

1. Dimensioned plan and elevation view drawings, including motor starter cabinet, required clearances, and location of all field piping and electrical connections.
2. Summaries of all auxiliary utility requirements such as: electricity, water, air, etc. Summary shall indicate quality and quantity of each required utility.
3. Diagram of control system indicating points for field interface and field connection. Diagram shall fully depict field and factory wiring.
4. Manufacturer's certified performance data at full load plus IPLV or NPLV.
5. Before shipment, submit a certification of satisfactory completion of factory run test signed by a company officer. The test shall be conducted according to AHRI Standard 550/590.
6. Installation and Operating Manuals.

#### 1.4 QUALITY ASSURANCE

- A. Qualifications: Equipment manufacturer must specialize in the manufacture of the products specified and have five years experience with the equipment and refrigerant offered.
- B. Regulatory Requirements: Comply with the codes and standards in Section 1.2.
- C. Chiller manufacturer plant shall be ISO Registered.

#### 1.5 DELIVERY AND HANDLING

- A. Chillers shall be delivered to the job site completely assembled and charged with refrigerant and oil.
- B. Comply with the manufacturer's instructions for rigging and transporting units. Leave protective covers in place until installation.

#### 1.6 WARRANTY

- A. The refrigeration equipment manufacturer's warranty shall be for a period of (one) -- OR -- (two) --Or-- (five) years from date of equipment start up or 18 months from shipment whichever occurs first. The warranty shall include parts and labor costs for the repair or replacement of defects in material or workmanship.

#### 1.7 MAINTENANCE

- A. Chiller maintenance shall be the responsibility of the owner with the following exceptions:
  1. The manufacturer shall provide the first year scheduled oil and filter change if required.
  2. The manufacturer shall provide first year purge unit maintenance if required.

### PART 2 — PRODUCTS

#### 2.1 ACCEPTABLE MANUFACTURERS

- A. Daikin
- B. (Approved Equal)

#### 2.2 UNIT DESCRIPTION

- A. Provide and install as shown on the plans a factory-assembled, factory charged water-cooled packaged chiller. Each unit shall be complete with a single-stage hermetic centrifugal compressor with lubrication and control system, factory mounted starter, evaporator, condenser, refrigerant control device and any other components necessary for a complete and operable chiller package.
- B. Each chiller shall be factory run-tested under load conditions for a minimum of one hour on an AHRI approved test stand with evaporator and condenser waterflow at job conditions (excluding glycol applications). Operating controls shall be adjusted and checked. The refrigerant charge shall be adjusted for optimum operation and recorded on the unit nameplate. Any deviation in performance or operation shall be remedied prior to shipment and the unit retested if necessary to confirm repairs or adjustments. Manufacturer shall supply a certificate of completion of a successful run-test upon request.
- C. Electrical components shall be housed in NEMA 1 enclosures, designed for clean, indoor locations.

#### 2.3 DESIGN REQUIREMENTS

- A. General: Provide a complete water-cooled hermetic centrifugal compressor water-chilling package as specified herein. Machine shall be provided according to referenced standards Section 1.2. In general, unit shall consist of a compressor, condenser, evaporator,

lubrication system, starter and control system.

**NOTE:** Chillers shall be charged with a refrigerant such as R-134a, not subject to the Montreal Protocol and the U. S. Clean Air Act.

- B. Performance: Refer to schedule on the drawings. The chiller shall be capable of stable operation to ten percent of full load with standard AHRI entering condensing water relief without the use of hot gas bypass.
- C. Acoustics: Sound pressure levels for the complete unit shall not exceed the following specified levels. Provide the necessary acoustic treatment to chiller as required. Sound data shall be measured according to AHRI Standard 575. Data shall be in dB. Data shall be the highest levels recorded at all load points. Test shall be in accordance with AHRI Standard 575.

## 2.4 CHILLER COMPONENTS

### A. Compressor:

1. Unit shall have a single-stage hermetic centrifugal compressor. Casing design shall ensure major wearing parts, main bearings, and thrust bearings are accessible for maintenance and replacement. The lubrication system shall protect machine during coast down period resulting from a loss of electrical power.
2. Impeller shall be statically and dynamically balanced. The compressor shall be vibration tested and not exceed a level of 0.14 IPS.
3. IGVs actuated by stepper motor
4. If compressor is not equipped with guide vanes for each stage and movable discharge diffusers, then furnish hot gas bypass and select chillers at 5% lower kW/ton than specified to compensate for bypass inefficiency at low loads.
5. For open motor units, an oil reservoir shall collect any oil and refrigerant that leaks past the seal. A float device shall be provided to open when the reservoir is full, directing the refrigerant/oil mixture back into the compressor housing.
6. Manufacturer shall warrant the shaft seal, reservoir, and float valve system against leakage of oil and refrigerant to the outside of the refrigerating unit for a period of 5 years from the initial start-up including parts and labor to replace a defective seal and any refrigerant required to trim the charge original specifications.

B. Lubrication System: Each compressor shall have an independent lubrication system to provide lubrication to all parts requiring oil. Provide a heater in the oil sump to maintain oil at sufficient temperature to minimize affinity of refrigerant, and a thermostatically controlled refrigerant-cooled oil cooler. A positive displacement oil pump shall be powered through the unit control transformer.

### C. Refrigerant Evaporator and Condenser:

1. Evaporator and condenser shall be of the shell-and-tube type, designed, constructed, tested and stamped

according to the requirements of the ASME Code, Section VIII. Regardless of the operating pressure, the refrigerant side of each vessel will bear the ASME stamp indicating compliance with the code and indicating a test pressure of 1.1 times the working pressure, but not less than 100 psig. Provide intermediate tube supports at a maximum of 24 inch spacing.

2. Tubes shall be enhanced for maximum heat transfer, rolled into steel tube sheets and sealed with Locktite, or equal sealer. The tubes shall be individually replaceable
3. Provide sufficient isolation valves and condenser volume to hold the full unit refrigerant charge in the condenser during servicing or provide a separate pumpout system and storage tank sufficient to hold the charge of the largest unit being furnished.
4. The water sides shall be designed for a minimum of 150 psi or as specified elsewhere. Vents and drains shall be provided.
5. An electronic refrigerant expansion valve shall control refrigerant flow to the evaporator. Fixed orifice devices or float controls with hot gas bypass are not acceptable because of inefficient control at low load conditions. The liquid line shall have a moisture indicating sight glass.
6. The evaporator and condenser shall be separate shells. A single shell containing both vessel functions is not acceptable because of the possibility of internal leaks.
7. Reseating type spring loaded pressure relief valves according to ASHRAE-15 safety code shall be furnished. The evaporator shall be provided with single or multiple valves. The condenser shall be provided with dual relief valves equipped with a transfer valve so one valve can be removed for testing or replacement without loss of refrigerant or removal of refrigerant from the vessel. Rupture disks are not acceptable.
8. The evaporator, suction line, and any other component or part of a component subject to condensing moisture shall be insulated with UL recognized 3/4 inch closed cell insulation, with an option for double insulation. All joints and seams shall be carefully sealed to form a vapor barrier.
9. Provide factory-mounted thermal dispersion flow switches on each vessel to prevent unit operation with no flow.

### D. Motor:

1. Squirrel cage induction motor of the hermetic type of sufficient size to efficiently fulfill compressor horsepower requirements. Motor shall be liquid refrigerant cooled with internal thermal overload protection devices embedded in the winding of each phase. Motor shall be compatible with the starting method specified hereinafter. If the Contractor chooses to provided an open drive motor or compressor, verify in the submittal that the scheduled chiller room ventilation system will accommodate the additional heat and maintain the equipment room at design indoor temperature based on 95.F outdoor ambient ventilation air available. If

additional cooling is required, manufacturer shall be responsible for the installation, wiring and controls of a cooling system. Chiller selection shall compensate for tonnage and efficiency loss to make certain the owner is not penalized.

**E. Motor Starter:**

1. The main motor starter is to be factory mounted and fully wired to the chiller components and factory tested during the run test of the unit.

**-- OR -**

The main motor starter is to be furnished by the chiller manufacturer and shipped loose for floor mounting and field wiring to the chiller package. It shall be free-standing with NEMA-1 enclosure designed for top entry and bottom exit and with front access.

2. For open drive air-cooled motors the chiller manufacturer shall be responsible for providing the cooling of the refrigeration machinery room. The sensible cooling load shall be based on the total heat rejection to the atmosphere from the refrigeration units.
3. The starter must comply with the codes and standards in Section 1.2.
4. **Low Voltage (200 through 575 volts)** controllers are to be continuous duty AC magnetic type constructed according to NEMA standards for Industrial Controls and Systems (ICS) and capable of carrying the specified current on a continuous basis. The starters shall be:

Solid-State Reduced Voltage - Starters shall be furnished with silicon controlled rectifiers (SCR) connected for starting and include a bypass contactor. When operating speed is reached, the bypass contactor shall be energized removing the SCRs from the circuit during normal running.

- a. All starters shall be coordinated with the chiller package(s) making certain all terminals are properly marked according to the chiller manufacturer's wiring diagrams.
- b. The starters shall be equipped with redundant motor control relays (MCR). The relays shall interconnect the starters with the unit control panels and directly operate the main motor contactors. The MCRs shall constitute the only means of energizing the motor starter.
- c. The main contactors shall have a normally open auxiliary contact rated at 125VA pilot duty at 115 VAC. An additional set of normally open contacts shall be provided for each MCR.
- d. There shall be electronic overloads in each phase which will permit continuous operation at 107% of the rated load amps of each motor. The overloads shall have a must-trip setting at 125% of the RLA. Overloads shall be manual reset and shall de-energize the main contactors when the overcurrent occurs. The overloads shall be adjustable and

selected for midrange. Overloads shall be adjustable, manual reset, ambient compensated, and set for class 10 operation.

- e. Each starter shall have a current transformer and adjustable voltage dropping resistor(s) to supply a 5.0 VAC signal at full load to the unit control panels.
- f. Each starter shall be equipped with a line to 115 VAC control transformer, fused in both the primary and secondary, to supply power to the control panels, oil heaters and oil pumps.
- g. Each starter shall include phase under/over voltage protection, phase failure and reversal protection, a load break disconnect switch and current limiting power fuses.

**-- OR -**

Variable Frequency Drive

- a. The chiller shall be equipped with an air-cooled Variable Frequency Drive (VFD) to automatically regulate each compressor speed in response to cooling load and compressor pressure lift requirement. Liquid cooling is unacceptable. If a condenser water-cooled VFD is supplied, the manufacturer shall supply factory installed dual water filters with a bypass valve and pressure differential switch factory wired to the chiller control panel to indicate that a filter has clogged and requires service. The pressure differential switch shall also provide a separate dry contact which can be connected to the BAS system as a means of notifying operating personnel of the need to service the filters. If the condenser cooling circuit includes an intermediate heat exchanger, it must be of the brush cleanable shell and tube style. Brazed plate heat exchangers which cannot be field cleaned are not acceptable. Movable inlet guide vanes and variable compressor speed shall provide unloading. The chiller controls shall coordinate compressor speed and guide vane position to optimize chiller efficiency.

**-- OR -**

**4 Medium Voltage (2400 through 6600 volts).** The starter shall be:

Solid-State Reduced Voltage - Starter shall be furnished with silicon controlled rectifiers (SCR) connected for starting and include a bypass contactor. When operating speed is reached, the bypass contactor shall be energized removing the SCRs from the circuit during normal running.

- a. The starter shall be coordinated with the chiller package(s) making certain all terminals are properly marked according to the chiller manufacturer's wiring diagrams.
- b. The starters shall be equipped with redundant motor control relays (MCR). The relays shall interconnect the starters with the unit control

panels and directly operate the main motor contactors. The MCRs shall constitute the only means of energizing the motor contacts.

- c. The main contactors shall have a normally-open auxiliary contact rated at 125VA pilot duty at 115 VAC. An additional set of normally open contacts shall be provided on the MCR.
- d. There shall be electronic overloads in each phase which will permit continuous operation at 107% of the rated load amps of each motor. Overloads shall be manual reset and shall de-energize the main contactors when the overcurrent occurs. The overloads shall be adjustable and selected for midrange. Overloads shall be adjusted for a locked rotor trip time of 8 seconds at full voltage and must trip in 60 seconds or less at reduced voltage (33% of delta LRA).
- e. Each starter shall have a current transformer and adjustable voltage dropping resistor(s) to supply a 5.0 VAC signal at full load to the unit control panels.
- f. Each starter shall be equipped with a line-to-220 VAC control transformer, fused in both the primary and secondary, to supply power to the control panels, oil heaters and oil pumps.
- g. Each starter shall include phase under/over voltage protection, phase failure and reversal protection, a load break disconnect switch and current limiting power fuses

-- OR -

Across-the-Line type with primary contactor allowing locked rotor amps to reach the motor when energized and including items a through g above.

All medium and higher voltage starters shall have the following components:

### 1. Main Control Relays

A motor control relay shall be provided to interlock the starter with the chiller. The relay shall constitute the only means of energizing the motor starter. No other devices (manual or automatic) with the capability of energizing the starter can be used. The starter is to be controlled by the unit microprocessor.

### 2. Motor Protection and Overloads

The starter shall include overload protection functions. These controls include:

- Solid state overload (overcurrent) protection
- Phase unbalance protection
- Phase reversal and phase loss protection.
- Adjustable overload to closely match motor performance
- Three current transformers to measure motor current and a fourth current transformer for input to the chiller microprocessor.

### 3. Undervoltage (UV) Relay

The undervoltage relay is an adjustable three-phase protec-

tion system that is activated when the voltage falls below a predetermined safe value and is factory set at 85% of nominal.

### 4. Control Voltage Transformer

The starter is to be provided with a 3KVA control transformer with both secondary and primary fuses to supply control power to the chiller.

### 5. Additional Standard Components

- Mechanical type solderless connectors to handle wire sizes indicated by NEC.
- Three isolated vertical line contactors
- Three-pole, gang operated non-load break isolating switch
- Three vertically mounted current limiting power fuse blocks (fuses included)
- Magnetic three-pole, vacuum break contactor
- Single phase control circuit transformer
- Vertically mounted control circuit primary current limiting fuses
- Current transformers
- Control circuit terminal blocks and secondary fuses
- Phase failure and reversal relay

### F. CHILLER CONTROLLER

Control enclosures shall be NEMA 1. The chiller shall have distributed control consisting of a unit controller, a compressor controller and a 15-inch super VGA color touch screen for operator interface with the control system.

The touch screen shall have graphics clearly depicting the chiller status, operating data, including water temperatures, percent RLA, water setpoint, alarm status and have STOP and AUTO control buttons.

The operator interface touch screen shall have inherent trend logging capabilities, which are transferable to other PC management systems such as an Excel spreadsheet via a USB port. Active trend logging data shall be available for viewing in 20 minute, 2 hour or 8 hour intervals. A full 24 hours of history is downloadable via a USB port. The following trended parameters shall be displayed:

- Entering and leaving chilled water temps
- Entering and leaving condenser water temps
- Evaporator saturated refrigerant pressure
- Condenser saturated refrigerant pressure
- Net oil pressure
- % rated load amps

In addition to the trended items above, other real-time operating parameters are also shown on the touch screen. These items can be displayed in two ways: by chiller graphic showing each component or from a color-coded, bar chart format. At a minimum, the following critical areas must be monitored:

- Oil sump temperature
- Oil feed line temperature
- Evaporator saturated refrigerant temperature
- Suction temperature

- Condenser saturated refrigerant temperature
- Discharge temperature
- Liquid line temperature

Unit setpoints shall be viewable on screens and changeable after insertion of a password. Complete unit operating and maintenance instructions shall be viewable on the touch screen and be downloadable via an onboard USB port. Complete fault history shall be displayed using an easy to decipher, color coded set of messages that are date and time stamped. The last 20 faults shall be downloadable from the USB port.

Automatic corrective action to reduce unnecessary cycling shall be accomplished through pre-emptive control of low evaporator or high discharge pressure conditions to keep the unit operating through ancillary transient conditions. System specific, chiller plant architecture software shall be employed to display the chiller, piping, pumps and cooling tower. Multi-chiller interconnection software for up to 4 WSC, WCC or WDC chillers shall be included also providing automatic control of: evaporator and condenser pumps (primary and standby), up to 4 stages of cooling tower fans and a cooling tower modulating bypass valve and/or cooling tower fan variable frequency drives. There shall be five possible tower control strategies:

1. Tower fan staging only – up to 4 stages controlled by either the entering condenser water temperature or lift differential temperature between the condenser and evaporator saturated temperatures.
2. Tower fan staging plus low limit - controlled as in # 1 plus tower bypass valve set at a minimum entering condenser water temperature
3. Tower staging with staged bypass control – similar to # 2 with additional control of the bypass valve between fan staging to smooth control and minimize fan staging.
4. VFD staging only – in this mode, a variable speed drive controls the first fan with up to 3 more fans to be staged on and off and there is no bypass valve.
5. VFD and Valve Staging – same as # 4 plus bypass valve control

Factory mounted DDC controller(s) shall support operation on a BACnet®, Modbus® or LONMARKS® network via one of the data link / physical layers listed below as specified by the successful Building Automation System (BAS) supplier.

- BACnet MS/TP master (Clause 9)
- BACnet IP, (Annex J)
- BACnet ISO 8802-3, (Ethernet)
- LONMARKS FTT-10A. The unit controller shall be LONMARKS® certified.

The information communicated between the BAS and the factory mounted unit controllers shall include the reading and writing of data to allow unit monitoring, control and alarm notification as specified in the unit sequence of operation and the unit points list. eXternal Interface File (XIF) shall be provided with the chiller submittal data. All communication from the chiller unit controller as specified in the points list shall be via standard BACnet objects. Proprietary BACnet objects shall not be allowed. BACnet communications shall conform to the

BACnet protocol (ANSI/ASHRAE135-2001). A BACnet Protocol Implementation Conformance Statement (PICS) shall be provided along with the unit submittal.

## 2.5. MISCELLANEOUS ITEMS

- A. Pumpout System: If the design of the unit does not allow the charge to be transferred to and isolated in the main condenser, it shall be equipped with an ASME pumpout system complete with a transfer pump, condensing unit, and storage vessel . The main condenser shall be sized to contain the refrigerant charge at 90.F according to ANSI-ASHRAE 15.A.
- B. Purge System (Negative Pressure Chillers Only):
  1. The chiller manufacturer shall provide a separate high efficiency purge system that operates independently of the unit and can be operated while the unit is off. The system shall consist of an air-cooled condensing unit, purge condensing tank, pumpout compressor and control system.
  2. A dedicated condensing unit shall be provided with the purge system to provide a cooling source whether or not the chiller is running. The condensing unit shall provide a low purge coil temperature to result in a maximum loss of 0.1 pounds of refrigerant per pound of purged air.
  3. The purge tank shall consist of a cooling coil, filter-drier cores, water separation tube, sight glass, drain, and air discharge port. Air and water are separated from the refrigerant vapor and accumulated in the purge tank.
  4. The pumpout system shall consist of a small compressor and a restriction device located at the pumpout compressor suction connection.
  5. The purge unit shall be connected to a 100% reclaim device.
- C. Vacuum Prevention System (negative pressure chillers only): Chiller manufacturer shall supply and install a vacuum prevention system for each chiller. The system shall constantly maintain 0.05 psig inside the vessel during non-operational periods. The system shall consist of a precision pressure controller, two silicon blanket heaters, a pressure transducer, and solid-state safety circuit.
- D. Refrigerant Detection Device (negative pressure chillers only): Chiller manufacturer shall supply and install a refrigerant detection device and alarm capable of monitoring refrigerant at a level of 10 ppm. Due to the critical nature of this device and possible owner liability, the chiller manufacturer shall guarantee and maintain the detection monitor for five years after owner acceptance of the system.
- E. Waffle type vibration pads for field mounting under unit feet.



## PART 3 — EXECUTION

### 3.1 INSTALLATION

- A. Install according to manufacturer's requirements, shop drawings, and Contract Documents.
- B. Adjust chiller alignment on concrete foundations, sole plates or subbases as called for on drawings.
- C. Arrange the piping on each vessel to allow for dismantling the pipe to permit head removal and tube cleaning.
- D. Coordinate electrical installation with electrical contractor.
- E. Coordinate controls with control contractor.
- F. Provide all material required to ensure a fully operational and functional chiller.

### 3.2 START-UP

- A. Units shall be factory charged with the proper refrigerant and oil.
- B. Factory Start-Up Services: The manufacturer shall provide factory authorized supervision for as long a time as is necessary to ensure proper operation of the unit, but in no case for less than two full working days. During the period of start-up, the start-up technician shall instruct the owner's representative in proper care and operation of the unit.



### ***Daikin Applied Training and Development***

Now that you have made an investment in modern, efficient Daikin Applied equipment, its care should be a high priority. For training information on all Daikin Applied HVAC products, please visit us at [www.DaikinApplied.com](http://www.DaikinApplied.com) and click on Training, or call 540-248-9646 and ask for the Training Department.

### ***Warranty***

All Daikin Applied equipment is sold pursuant to its standard terms and conditions of sale, including Limited Product Warranty. Consult your local Daikin Applied representative for warranty details. To find your local Daikin Applied representative, go to [www.DaikinApplied.com](http://www.DaikinApplied.com).

### ***Aftermarket Services***

To find your local parts office, visit [www.DaikinApplied.com](http://www.DaikinApplied.com) or call 800-37PARTS (800-377-2787). To find your local service office, visit [www.DaikinApplied.com](http://www.DaikinApplied.com) or call 800-432-1342.

This document contains the most current product information as of this printing. For the most up-to-date product information, please go to [www.DaikinApplied.com](http://www.DaikinApplied.com).

Products manufactured in an ISO Certified Facility.